

# SENCOR®

SVC 9829WH



3-IN-1 CORDLESS VACUUM CLEANER

Translation of the original manual



**SENCOR®**

**SVC 9829WH**



**A**

**1**

**2**

**3**

**4**

**5**

**6**

**7**

**8**

**9**

**10**

**11**

**12**

**13**

**14**

**15**

**16**

**17**

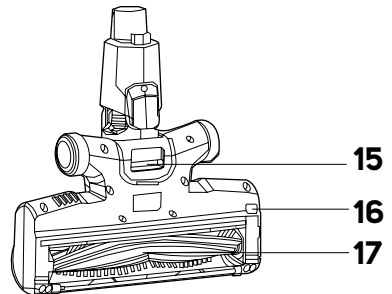
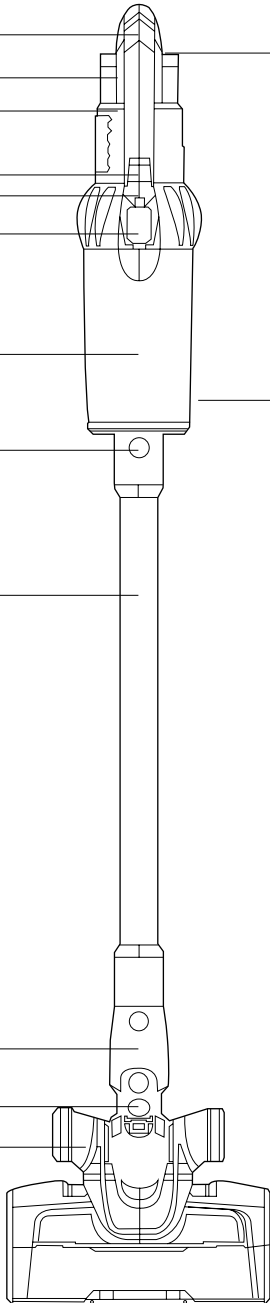

**A**

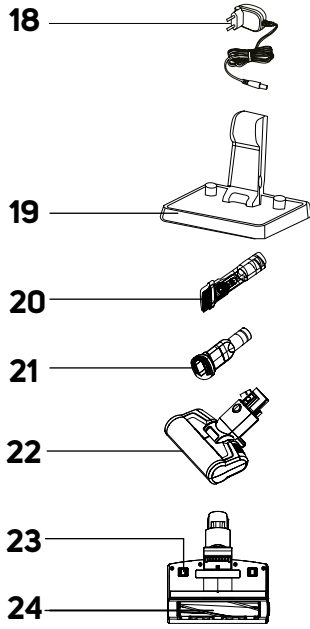

**C**

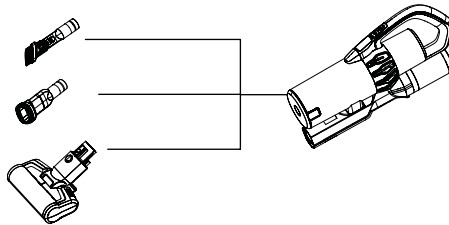

**D**

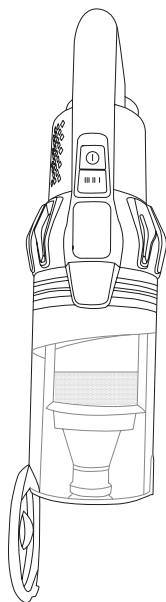

**E1**

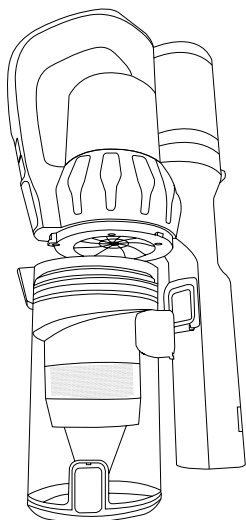

**E2**

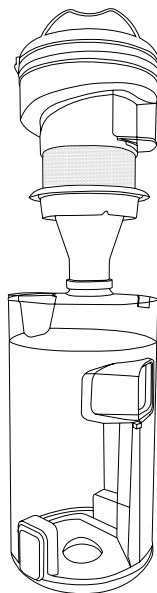

**F**



**G**

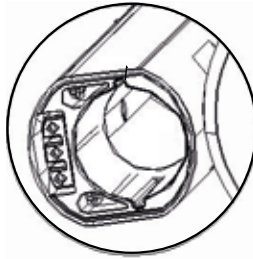

# EN 3-in-1 Cordless vacuum cleaner

## Important safety instructions

### READ CAREFULLY AND STORE FOR FUTURE USE.

- This vacuum cleaner may be used by children 8 years of age and older and by persons with physical, sensory or mental impairments or by inexperienced persons, if they are properly supervised or have been informed about how to use this vacuum cleaner in a safe manner and understand the potential dangers.
- Children must not play with the appliance. Cleaning and maintenance performed by the user must not be performed by unsupervised children.
- In the event that the power adapter is damaged, it must be replaced with an original type. For a replacement power adapter, please contact an authorised service centre. It is forbidden to use the appliance if it has a damaged power adapter.



#### **WARNING:**

Avoid coming into contact with the rotating parts of the vacuum cleaner's hand accessories. There is a risk of getting caught on these parts and possible injury.

Only use the vacuum cleaner with the original power adapter, charging base and accessories that were supplied with it.

- This vacuum cleaner is designed for use in households, offices and similar types of areas. Do not use in industrial surroundings.
- Do not expose the vacuum cleaner to direct sunlight and do not place it near an open fire or appliances that are a source of heat.
- Before connecting the adapter to a power socket, check that the technical details on its rating label match the electrical voltage in the power socket.
- Make sure the adapter power cord is not touching a hot surface or sharp objects. Position the adapter power cord so that it will not be tripped over.
- Never submerge the vacuum cleaner, the charging base or the power adapter in water or any other liquid and do not wash it under running water.
- Before turning on the vacuum cleaner, make sure that it is correctly assembled and that all inflow and outflow filters are installed in their place.
- When the vacuum cleaner is running, ensure that the air outlets and the suction opening are not blocked.
- Do not use the vacuum cleaner to vacuum the following items:
  - smouldering cigarettes, burning items, matches or embers;
  - water and other liquids;
  - flammable or volatile materials;
  - sharp items, e.g. broken glass, needles, pins, etc.;
  - flour, wall plaster, cement and other building materials;
  - larger pieces of paper or plastic bags, which can easily block the suction hole.
- Vacuuming of some types of floors or floor surfaces can create an electrostatic discharge, which presents no danger to the user.
- Always turn off the vacuum cleaner when leaving it without supervision, after finishing using it and before cleaning it.
- Disconnect the power adapter from the power socket before cleaning it and after it has finished charging.
- Disconnect the power adapter from the power socket by pulling on the plug, never pulling on the power cord. Otherwise, this could damage the power adapter or the socket.
- If the power adapter is damaged, it must be replaced with an original type. For a replacement power adapter, please contact an authorised service centre.
- Do not use the vacuum cleaner if it is not working correctly, if it has been damaged or has been submerged in water.
- Do not repair the vacuum cleaner yourself or make any adjustments to it. Have all repairs or adjustments performed at an authorised service centre. By tampering with the appliance, you risk voiding your legal rights arising from unsatisfactory performance or quality warranty.



- Thank you for purchasing a SENCOR brand product and we hope that you will be happy with it.
- Prior to using this appliance, please read the user's manual thoroughly, even in cases, when one has already familiarised themselves with previous use of similar types of appliances. Only use the appliance in the manner described in this user's manual. Keep this user's manual in a safe place where it can be easily retrieved for future use.
- We recommend saving the original cardboard box, packaging material, purchase receipt and responsibility statement of the vendor or warranty card for at least the duration of the legal liability for unsatisfactory performance or quality. In the event of transportation, we recommend that you pack the appliance in the original box from the manufacturer.

### 2. Combination crevice nozzle

- It is suitable for vacuuming hard to reach places (e.g. windows, corners, book shelves, areas between mattresses, upholstery, etc.). Press and hold down the button and slide out the brush by moving it forward. Retract the brush by pressing the button and moving it backwards.

### 3. Combination nozzle for upholstery and furniture

- This attachment is suitable for vacuuming surfaces such as furniture or upholstery. Press and hold down the button and slide out the brush by moving it forward. Thanks to its fine bristles, it is suitable for removing dust and dirt from fine surfaces such as curtains, drapes, etc. Retract the brush by pressing the button and moving it backwards.



#### Note:

The various options for combining the accessories are shown in figure C.

### DESCRIPTION OF THE VACUUM CLEANER

<b>A1</b> Handle	<b>A15</b> Hole with magnet for the wiping attachment
<b>A2</b> Battery	<b>A16</b> Electric rotary brush release button
<b>A3</b> Motor unit	<b>A17</b> Electric rotary brush
<b>A4</b> On/Off button	<b>A18</b> Power adapter
<b>A5</b> Power level button	<b>A19</b> Stand
<b>A6</b> Display	<b>A20</b> Combination nozzle for upholstery and furniture
<b>A7</b> Dust container	<b>A21</b> Combination crevice nozzle
<b>A8</b> Metal tube release clip	<b>A22</b> "Cat&Dog Mini" nozzle with an electric rotary brush
<b>A9</b> Metal tube	<b>A23</b> Castors
<b>A10</b> Floor nozzle release clip	<b>A24</b> Rotary brush
<b>A11</b> Floor nozzle	
<b>A12</b> Travel wheels	
<b>A13</b> Battery release button	
<b>A14</b> Button for releasing the bottom of the dust container for fast emptying of dust and dirt	

### ASSEMBLING AND DISASSEMBLING THE VACUUM CLEANER

#### 1. ASSEMBLING AND DISASSEMBLING THE CORDLESS VACUUM CLEANER

- Place the floor nozzle on an even, dry and stable surface. Put the tube on to the floor nozzle in such a way that the connectors in the rear part of the floor nozzle align with the opening inside the tube. Push the tube in until you hear a click.
- Insert the outlet hole of the motor unit into the tube in such a way that the connectors in the rear part of the nozzle align with the opening inside the outlet hole.
- If you need to disassemble the cordless vacuum cleaner, press the motor unit release clip on the metal tube. Then press the floor nozzle release clip to release the floor nozzle.

#### 2. ASSEMBLING AND DISASSEMBLING THE VACUUM CLEANER WITH ACCESSORIES

- In order to perfectly clean your home, you can attach some of the supplied accessories to the motor unit outlet. Simply remove the accessory by pulling it out of the motor unit outlet. On the rotary brush, first press its release clip.

##### 1. "Cat&Dog Mini" rotary brush with independent motor

- The "Cat&Dog" rotary brush is the suitable for removing animal fur, hair, etc., while at the same time being suitable for vacuuming hard-to-reach places. Its use is not limited to the home, and can be used for vacuuming the car. It quickly and effectively removes hair, animal fur and other materials from car seats, upholstery, pillows and other textile surfaces.

### CHARGING THE BATTERY

- The battery is partially charged from the factory and it needs to be charge to full capacity.
- Place the stand in an even, stable and dry location at a sufficient distance from the power socket. Connect the connector of the power adapter into the socket on the side of the stand and the power adapter plug into a power socket.
- Insert the assembled vacuum cleaner into the stand so that the contacts on the rear part of the floor nozzle slide into the contacts on the stand.
- The display will show a battery status indicator that is lit red and the charging status as a percentage. As a rule, the charging process takes 5,5 hours.
- As soon as the battery is fully charged, the battery status indicator light will be lit white.
- When you finish cleaning and have cleaned out the appliance, place it back into the stand so that the battery can recharge.
- Keep the charging adapter plugged in permanently. The electronics in the appliance control the battery charging process and ensure that it is always optimally charged. When the battery is fully charged, the electronics interrupt the charging process and resume it when it is necessary to charge the battery again. There is no need to worry about wasting electricity.
- Disconnect the charging adapter from the power socket only in the event of a long term absence. When you return, plug it back into the socket so that the vacuum cleaner is again ready for use.
- Before first use, allow the battery to charge for up to 12 hours and allow it to fully discharge before charging it again. We recommend repeating this procedure three times in total. This will ensure the long operational lifetime of the battery.
- The display shows the battery charge level. If the charge level falls below 20%, the vacuum cleaner will automatically switch from the high power level to the medium/low power level. It will not be possible to set the high power level. The display will show a red battery symbol, which indicates that it is necessary to charge the battery.
- When the battery is almost flat, the vacuum cleaner will stop running in order to prevent the battery from discharging fully.

### INSERTING AND REMOVING THE BATTERY

- 1. Inserting the battery:** Hold the vacuum cleaner with one hand and insert the battery into the vacuum cleaner with the other so that the grooves on the motor unit slide into the slots in the battery. Push on the battery in until you hear a click. The battery can only be inserted in one way.

**Warning:**

Never insert the battery in reverse or by using excessive force. This could damage it.

2. **Removing the battery:** If you need to remove the battery, press the button on the top part of the battery to release it. Hold the button pushed down and carefully pull the battery from the motor unit.

**Warning:**

When not using the vacuum cleaner for an extended period of time, take the battery out of it and store it in a cool, dry location. Regularly recharge the battery. Store it away from metal objects to prevent excessive discharging from occurring.

**USING THE CORDLESS VACUUM CLEANER**

1. Assemble the cordless vacuum cleaner according to the instructions in section "ASSEMBLING AND DISASSEMBLING THE CORDLESS VACUUM CLEANER".
2. Press the On/Off button and the vacuum cleaner will start at the default low power level. "ECO" will appear on the screen.
3. Press the mode level button again to set the desired power level: Low power: the display will show "ECO" and the bar will be lit to 1/3; Medium power: the display will show "MID" and the bar will be lit to 2/3; High power: the display will show "MAX" and the bar will be fully lit; Automatic mode: the display will show "AUTO" and the bar will be lit based on the power output. In automatic mode the power output level is adjusted based on the detected level of soiling and type of the floor. If the floor is heavily soiled, the vacuum cleaner will automatically set a high power level and vice versa.
4. When you have finished vacuuming, turn the vacuum cleaner off by pressing the On/Off button, the vacuum cleaner will turn off and the display will turn off.

**Note:**

The electric rotary brush will stop automatically in the event that it is blocked, e.g. by a foreign object or a large amount of hair or fur. This is a safety feature that protects the brush against damage. If this happens, turn the vacuum cleaner off by pressing the On/Off button and remove the jammed object or hair from the brush.

If the charge level falls below 20%, the vacuum cleaner will automatically switch from the high power level to the medium/low power level. It will not be possible to set the high power level. The display will show a red battery symbol, which indicates that it is necessary to charge the battery.

**CLEANING AND MAINTENANCE**

- Always make sure that the vacuum cleaner is turned off before cleaning it. Remove the battery from the motor unit.

**CLEANING THE MOTOR UNIT AND ACCESSORIES**

- To clean the outer parts of the vacuum cleaner, use a soft cloth dipped in lukewarm water. Do not use aggressive cleaning agents, paint thinners or solvents. Using these solutions could damage the surface of the appliance.

**CLEANING THE CORDLESS VACUUM CLEANER****Emptying the dust container**

- It is recommended to always empty out the dust container after every use. If, however, the level of dust and dirt reaches the MAX mark, it is necessary to immediately dump out the dust container.
1. Remove the attached accessory from the motor unit.
  2. Take the motor unit over to a garbage bin so that the bottom of the dust container points downwards.
  3. Press the dust container release button. This will release and open it – see figure D.

4. In this way, you will dump the contents of the container directly into the garbage bin.
5. Use your hand to close the bottom of the container. The bottom of the dust container is securely locked in place when you hear a click.

**Note:**



For hygiene reasons, we recommend that you dump out the container away from living areas.

**Cleaning the dust container**

- Regularly clean the dust container to prevent unpleasant odours from being created.
1. Remove the attached accessories from the motor unit and dump out the dust container according to the above mentioned instructions.
  2. Turn the container clockwise to the  symbol and carefully remove it from the motor unit – see figure E1.
  3. Grasp the entire filtration unit by the handle and take it out of the container – see figure E2.
  4. Turn the HEPA filter anticlockwise to release it, and take it out.
  5. Remove dust and dirt from the tubular filter. If necessary, you can rinse it under clean running water. Then wipe them dry using a clean wiping cloth.
  6. Remove the foam filter from the underside of the HEPA filter. Tap it out over a garbage bin. Do not squeeze the foam into water or vacuum it using a vacuum cleaner. This risks its irreparable damage.
  7. Tap out the HEPA filter and remove the dirt and dust from it using a fine brush or soft wiping cloth. In the event of heavy soiling, you can vacuum it out using a different vacuum cleaner with an attached brush nozzle. Do not wash the HEPA filter in water. This could damage it. In the event that the HEPA filter is already heavily soiled or deformed, replace it with a new one. We recommend replacing the HEPA filter based on the frequency of use, at least once every six months.
  8. Wipe the inside walls of the dust container using a soft lightly dampened sponge. Wipe dry using a clean wiping cloth.

**Warning:**

Never install the filters if they are wet or damp. Make sure that they are completely dry before installing them.

9. Put the foam filter on to the bottom of the HEPA filter and then place it on the tubular filter so that the "line" on the filter points to the  symbol on the filter unit. Turn it clockwise to the  symbol to secure it in place.
10. Insert the assembled filtration unit into the dust container so that the cut-out and the notch fit together and the entire filter unit is pushed all the way to the bottom of the container.
11. Put the dust container against the motor unit so that the tab on the front part of the motor unit is aligned with the opening in the top part of the container. Then turn it anticlockwise to the  symbol until you hear a click.

**Cleaning the floor nozzle**

- It is necessary to regularly clean the floor nozzle to ensure the required level of continuous suction power.
1. Take the floor nozzle off the vacuum cleaner and turn it upside down.
  2. Press the rotary brush clip to release the side cover – see figure F.
  3. Carefully take out the rotary brush.
  4. Remove any wound on hair, fur and other dirt from the rotary brush. To speed up the removal of wound on hair or fur, you can use scissors.
  5. Wipe out the internal area of the floor nozzle using a dry wiping cloth.
  6. Insert the clean rotary brush back into the floor nozzle. Correct attachment is indicated by a click.

**Cleaning the Cat&Dog Mini brush**

It is necessary to clean the Cat&Dog Mini brush regularly to ensure the desired and stable suction power.

1. Remove the rotary brush from the vacuum cleaner and turn it upside down.
2. Turn the lock to release the brush and take it out.

3. Remove tangled hair, animal hair and other dirt from the brush. You can use scissors to remove tangled hair or animal hair quicker.
4. Clean the inner part of the rotary brush by a dry cloth.
5. Place the brush back and turn the lock until it clicks.

#### Storage

- When not using the vacuum cleaner, clean it according to the aforementioned instructions and take the battery off the motor unit.
- Before storing it, check that the vacuum cleaner and all its accessories are thoroughly clean and dry.
- Store the appliance in a dry, clean and well-ventilated location not exposed to extreme temperatures and out of children's reach.
- We recommend that you regularly recharge batteries, i.e. every 6 months.

#### TROUBLESHOOTING

- Before you decide to contact an authorised service centre, please read through the following table:

Problem	Possible cause	Solution
The vacuum cleaner will not turn on.	The battery is flat.	Recharge the battery before using the vacuum cleaner.
	The vacuum cleaner is not properly assembled.	Check that all the components are properly assembled.
Suction power is weak	The dust container is full or the filters are dirty.	Empty out the dust container and clean the filters.
	There is a large amount of hair and fur wound on to the rotary brush.	Clean the rotary brush.
The battery has a short lifetime.	The battery is not fully charged.	Recharge the battery.
	The battery is at the end of its lifetime.	Purchase a new battery.





#### Attention:

If your problem is not specified in the above table or the specified problem continues to persist, stop using the vacuum cleaner, turn it off and contact an authorised service centre.

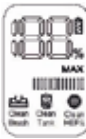
#### Malfunction icons

-  If the suction hole is blocked or full of dust, the icons of the floor nozzle, dust container and the HEPA filter will gradually light up on the display, one after the other in 1-second intervals. This indicates that it is necessary to check one after the other, whilst the power level and the power bar are displayed. After removing the blockage, the icons on the display will turn off.
- If you turn on the vacuum cleaner with the automatic power level set and the red indicator is lit on the display, it is possible that the dust detection sensor may be clogged. The dust volume detector is located on the bottom part of the inlet into the motor unit – see figure 6.

#### Error messages

Error message	Meaning	Solution	
E1	Disconnection error, the battery is not charging. It is damaged.	Contact an authorised service centre.	
E2	Voltage is too high (> 36.3 V). It is not possible to charge the vacuum cleaner. The adapter is damaged / a different adapter is used / battery is damaged.		
E3	Short circuit on the main motor when using the vacuum cleaner. The vacuum cleaner will turn itself off automatically. The motor or the battery is damaged.		
E5	Secondary excessive current in the motor unit during the use of the vacuum cleaner. The vacuum cleaner will turn itself off automatically.		
E6	Protection against overvoltage on the motor unit during the use of the vacuum cleaner. The vacuum cleaner will turn itself off automatically.		
E7	Error of the serial communications port, it is not possible to turn off the vacuum cleaner.		
E8	Thermistor error (faulty circuit, disconnection). The vacuum cleaner will turn itself off automatically. Battery temperature sensor is damaged.		
E9	Operation during high or low temperature. The vacuum cleaner will turn itself off automatically.		Wait until the vacuum cleaner heats up (low temperature) or cools down (high temperature) to room temperature.
 Clean Brush	Brush damage protection was activated because brush stopped moving during operation. The brush is blocked.		Eliminate the cause of the blockage and clean out the floor nozzle according to the instructions in section "Cleaning and maintenance".
 Clean Tank	Suction hole protection was activated. The suction hole is blocked by a foreign object.	Eliminate the cause of the blockage and clean out the suction hole according to the instructions in section "Cleaning and maintenance".	
	The vacuum cleaner will automatically turn off after 5 seconds. The operating current is <1 A. The motor unit or battery is damaged.	Contact an authorised service centre.	



#### Attention:

If the error message is not specified in the above table or continues to persist, stop using the vacuum cleaner, turn it off and contact an authorised service centre.

## TECHNICAL SPECIFICATIONS

### Power adapter

Input.....100–240 V~, 50/60 Hz, 1.5 A  
Output.....34.2 V , 0.6 A

### Vacuum cleaner

Power input.....550 W  
Electric rotary brush.....50 W  
Electric Cat&Dog rotary brush.....5 W  
Battery.....Li-ion / 28.8 V  / 3 000 mAh  
Time required for charging to full capacity.....approximately 5.5 hours  
Noise level.....≤ 83 dB(A)  
Dust container capacity.....0.5 l

The declared noise emission level of the appliance is ≤ 83 dB(A), which represents a level A of acoustic power with respect to a reference acoustic power of 1 pW.

Name of manufacturer	FAST ČR, a.s. U Sanitasu 1621 CZ-251 01 Říčany
Model identification number	Adapter for SVC 9829WH
Input voltage	100–240 V~
Input frequency	50/60 Hz
Output voltage	34.2 V 
Output current	1.2 A
Output power	41.04 W
Average efficiency in the active mode	91.29 %
Efficiency at low load (10 %)	89.45 %
Power consumption without load	0.054 W

Changes to text and technical parameters reserved.

### Double insulation symbol



#### Safety class for electrical shock protection:

Class II – Electrical shock protection is provided by double or heavy-duty insulation.



#### House symbol (domestic use)

The product is intended for household use only. The product is not intended for outdoor use.



#### Read user's manual symbol

Thoroughly read the all the instructions before using the product.



This symbol indicates that the appliance must not be used if the power plug is damaged.

## DISPOSAL OF BATTERIES



Prior to disposing of the product or handing it over at a specialised collection facility, it is necessary to ensure that the battery is removed. Before removing the battery, it is necessary to start the vacuum cleaner and wait until it is completely flat. The battery contains environmentally damaging substances and therefore does not belong in standard household waste. Their correct disposal will be performed by the respective collection facility.

## INSTRUCTIONS AND INFORMATION REGARDING THE DISPOSAL OF USED PACKAGING MATERIALS

Dispose of used packaging material at a site designated for waste in your municipality.

## DISPOSAL OF USED ELECTRICAL AND ELECTRONIC EQUIPMENT



This symbol on products or original documents means that used electric or electronic products must not be added to ordinary municipal waste. For proper disposal, renewal and recycling, hand these appliances over to determined collection points. Alternatively, in some European Union states or other European countries you may return your appliances to the local retailer when buying an equivalent new appliance. Correct disposal of this product helps save valuable natural resources and prevents potential negative effects on the environment and human health, which could result from improper waste disposal. Ask your local authorities or collection facility for more details. In accordance with national regulations penalties may be imposed for the incorrect disposal of this type of waste.

### For business entities in European Union states

If you want to dispose of electrical or electronic equipment, ask your retailer or supplier for the necessary information.

### Disposal in other countries outside the European Union.

This symbol is valid in the European Union. If you wish to dispose of this product, request the necessary information about the correct disposal method from the local council or from your retailer.



This product meets all the basic requirements of EU directives related to it.

