

User Manual

3KW/5KW INVERTER / CHARGER

Table Of Contents

ABOUT THIS MANUAL	1
Purpose.....	1
Scope.....	1
SAFETY INSTRUCTIONS.....	1
INTRODUCTION	2
Features.....	2
Basic System Architecture	2
Product Overview.....	3
INSTALLATION	4
Unpacking and Inspection.....	4
Preparation	4
Mounting the Unit.....	4
Battery Connection	5
AC Input/Output Connection	6
PV Connection	7
Final Assembly.....	8
Remote Display Panel Installation	9
Communication Connection.....	10
Dry Contact Signal	10
OPERATION.....	11
Power ON/OFF	11
Operation and Display Panel	11
LCD Display Icons	12
LCD Setting.....	14
Display Setting	22
Operating Mode Description	27
Fault Reference Code.....	29
Warning Indicator.....	29
Battery Equalization	30
SPECIFICATIONS	32
Table 1 Line Mode Specifications	32
Table 2 Battery Mode Specifications	33
Table 3 Charge Mode Specifications	34
Table 4 ECO/Bypass Mode Specifications.....	35
TROUBLE SHOOTING	36
Appendix I: Approximate Back-up Time Table	37

ABOUT THIS MANUAL

Purpose

This manual describes the assembly, installation, operation and troubleshooting of this unit. Please read this manual carefully before installations and operations. Keep this manual for future reference.

Scope

This manual provides safety and installation guidelines as well as information on tools and wiring.

SAFETY INSTRUCTIONS



WARNING: This chapter contains important safety and operating instructions. Read and keep this manual for future reference.

1. Before using the unit, read all instructions and cautionary markings on the unit, the batteries and all appropriate sections of this manual.
2. **CAUTION** --To reduce risk of injury, charge only deep-cycle lead acid type rechargeable batteries. Other types of batteries may burst, causing personal injury and damage.
3. Do not disassemble the unit. Take it to a qualified service center when service or repair is required. Incorrect re-assembly may result in a risk of electric shock or fire.
4. To reduce risk of electric shock, disconnect all wirings before attempting any maintenance or cleaning. Turning off the unit will not reduce this risk.
5. **CAUTION** – Only qualified personnel can install this device with battery.
6. **NEVER** charge a frozen battery.
7. For optimum operation of this inverter/charger, please follow required spec to select appropriate cable size. It's very important to correctly operate this inverter/charger.
8. Be very cautious when working with metal tools on or around batteries. A potential risk exists to drop a tool to spark or short circuit batteries or other electrical parts and could cause an explosion.
9. Please strictly follow installation procedure when you want to disconnect AC or DC terminals. Please refer to INSTALLATION section of this manual for the details.
10. Fuses are provided as over-current protection for the battery supply.
11. GROUNDING INSTRUCTIONS -This inverter/charger should be connected to a permanent grounded wiring system. Be sure to comply with local requirements and regulation to install this inverter.
12. NEVER cause AC output and DC input short circuited. Do NOT connect to the mains when DC input short circuits.
13. **Warning!!** Only qualified service persons are able to service this device. If errors still persist after following troubleshooting table, please send this inverter/charger back to local dealer or service center for maintenance.

INTRODUCTION

This is a multi-function inverter/charger, combining functions of inverter, MPPT solar charger and battery charger to offer uninterruptible power support with portable size. Its comprehensive LCD display offers user-configurable and easy-accessible button operation such as battery charging current, AC/solar charger priority, and acceptable input voltage based on different applications.

Features

- Pure sine wave inverter
- Built-in MPPT solar charge controller
- Configurable input voltage range for home appliances and personal computers via LCD setting
- Configurable battery charging current based on applications via LCD setting
- Configurable AC/Solar Charger priority via LCD setting
- Compatible to mains voltage or generator power
- Auto restart while AC is recovering
- Overload/ Over temperature/ short circuit protection
- Smart battery charger design for optimized battery performance
- Cold start function
- Zero-transfer Time

Basic System Architecture

The following illustration shows basic application for this inverter/charger. It also includes following devices to have a complete running system:

- Generator or Utility.
- PV modules

Consult with your system integrator for other possible system architectures depending on your requirements. This inverter can power all kinds of appliances in home or office environment, including motor-type appliances such as tube light, fan, refrigerator and air conditioner.

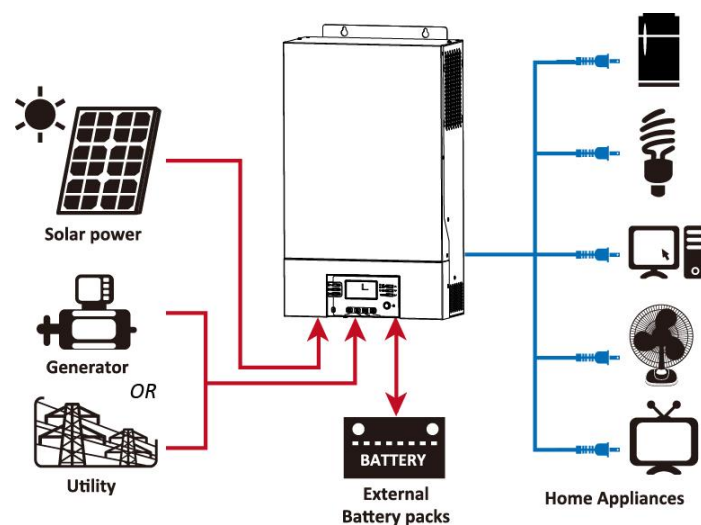
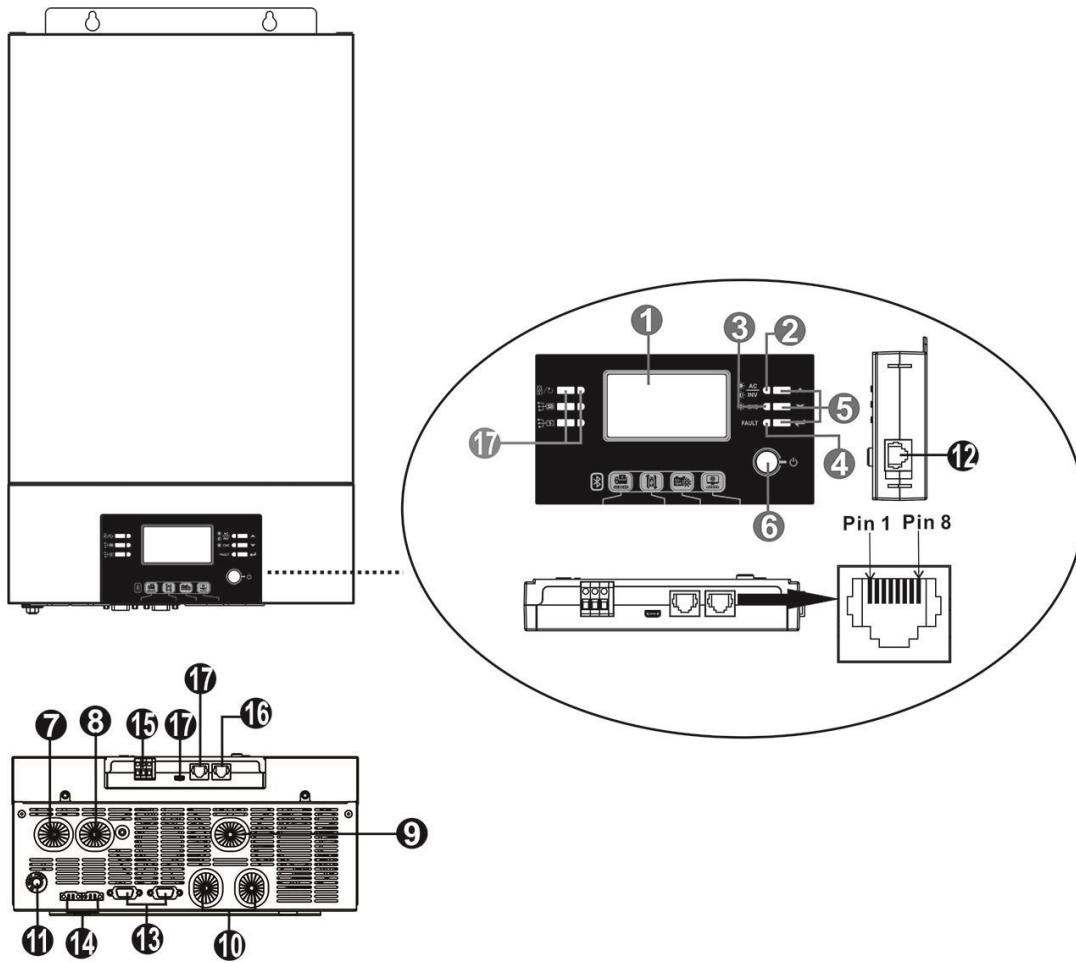

Figure 1 Hybrid Power System

Product Overview



1. LCD display
2. Status indicator
3. Charging indicator
4. Fault indicator
5. Function keys (Please refer to operation chapter for the detailed operation)
6. Power on/off switch
7. AC input
8. AC output
9. PV input
10. Battery input
11. Circuit breaker
12. Remote LCD panel communication port
13. Parallel communication cable (only for parallel model)
14. Current sharing cable (only for parallel model)
15. Dry contact
16. RS-232 communication port
17. Reserved for future use

NOTE: For parallel model installation and operation, please check separate parallel installation guide for the details.

INSTALLATION

Unpacking and Inspection

Before installation, please inspect the unit. Be sure that nothing inside the package is damaged. You should have received the following items inside of package:

- The unit x 1
- User manual x 1
- Communication cable x 1
- Software CD x 1

Preparation

Before connecting all wirings, please take off bottom cover by removing two screws as shown below.

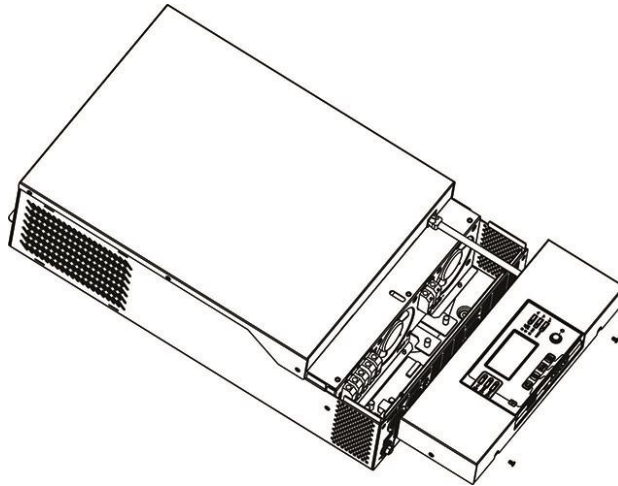

Mounting the Unit

Consider the following points before selecting where to install:

- Do not mount the inverter on flammable construction materials.
- Mount on a solid surface
- Install this inverter at eye level in order to allow the LCD display to be read at all times.
- The ambient temperature should be between 0°C and 55°C to ensure optimal operation.
- The recommended installation position is to be adhered to the wall vertically.
- Be sure to keep other objects and surfaces as shown in the right diagram to guarantee sufficient heat dissipation and to have enough space for removing wires.

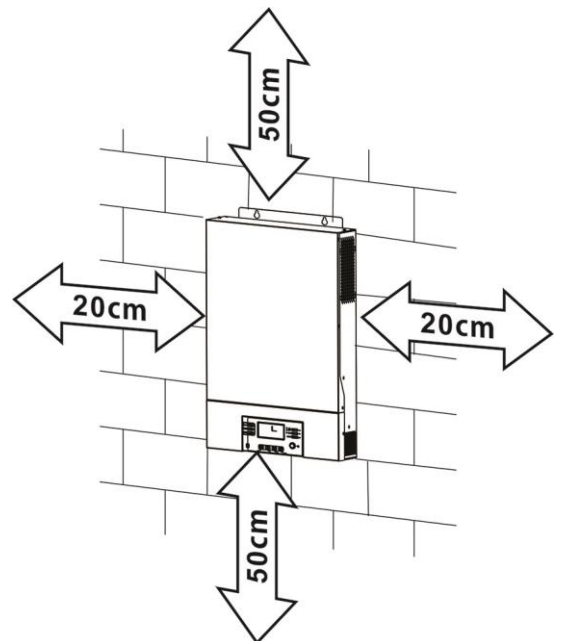

SUITABLE FOR MOUNTING ON CONCRETE OR OTHER NON-COMBUSTIBLE SURFACE ONLY.

Install the unit by screwing three screws. It's recommended to use M4 or M5 screws.

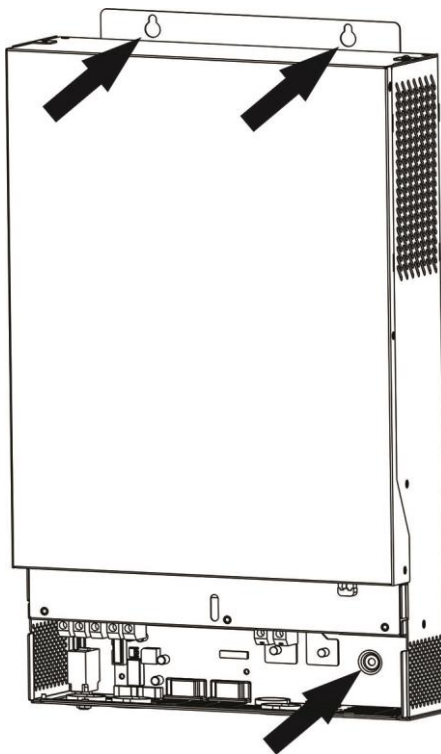

Battery Connection

CAUTION: For safety operation and regulation compliance, it's requested to install a separate DC over-current protector or disconnect device between battery and inverter. It may not be requested to have a disconnect device in some applications, however, it's still requested to have over-current protection installed. Please refer to typical amperage in below table as required fuse or breaker size.

WARNING! All wiring must be performed by a qualified personnel.

WARNING! It's very important for system safety and efficient operation to use appropriate cable for battery connection. To reduce risk of injury, please use the proper recommended cable and terminal size as below.

Ring terminal:

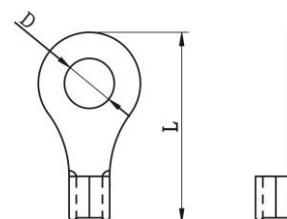

Recommended battery cable and terminal size:

Model	Typical Amperage	Battery Capacity	Wire Size	Ring Terminal			Torque Value
				Cable mm ²	Dimensions		
					D (mm)	L (mm)	
3KW	200A	200AH	1*1/0AWG	60	6.4	49.7	2~3 Nm
			2*4AWG	44	6.4	49.7	
5KW	200A	200AH	1*1/0AWG	60	6.4	49.7	2~3 Nm
			2*4AWG	44	6.4	49.7	

Please follow below steps to implement battery connection:

1. Assemble battery ring terminal based on recommended battery cable and terminal size.
2. Connect all battery packs as units requires. It's suggested to connect at least 200Ah capacity battery for 3KW model and at least 200Ah capacity battery for 5KW model.
3. Insert the ring terminal of battery cable flatly into battery connector of inverter and make sure the bolts are tightened with torque of 2-3 Nm. Make sure polarity at both the battery and the inverter/charge is correctly connected and ring terminals are tightly screwed to the battery terminals.

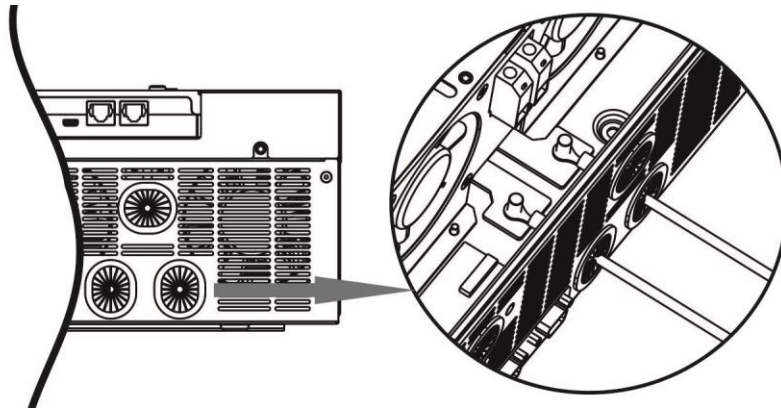

WARNING: Shock Hazard
Installation must be performed with care due to high battery voltage in series.

CAUTION!! Do not place anything between the flat part of the inverter terminal and the ring terminal. Otherwise, overheating may occur.
CAUTION!! Do not apply anti-oxidant substance on the terminals before terminals are connected tightly.
CAUTION!! Before making the final DC connection or closing DC breaker/disconnector, be sure positive (+) must be connected to positive (+) and negative (-) must be connected to negative (-).

AC Input/Output Connection

CAUTION!! Before connecting to AC input power source, please install a **separate** AC breaker between inverter and AC input power source. This will ensure the inverter can be securely disconnected during maintenance and fully protected from over current of AC input. The recommended spec of AC breaker is 30A for 3KW, 50A for 5KW.

CAUTION!! There are two terminal blocks with "IN" and "OUT" markings. Please do NOT mis-connect input and output connectors.

WARNING! All wiring must be performed by a qualified personnel.

WARNING! It's very important for system safety and efficient operation to use appropriate cable for AC input connection. To reduce risk of injury, please use the proper recommended cable size as below.

Suggested cable requirement for AC wires

Model	Gauge	Torque Value
3KW	10 AWG	1.2~ 1.6 Nm
5KW	8 AWG	1.4~ 1.6Nm

Please follow below steps to implement AC input/output connection:

1. Before making AC input/output connection, be sure to open DC protector or disconnecter first.
2. Remove insulation sleeve 10mm for six conductors. And shorten phase L and neutral conductor N 3 mm.
3. Insert AC input wires according to polarities indicated on terminal block and tighten the terminal screws. Be sure to connect PE protective conductor (⊕) first.

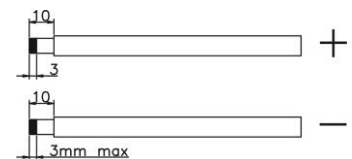

⊕ → **Ground (yellow-green)**

L → **LINE (brown or black)**

N → **Neutral (blue)**

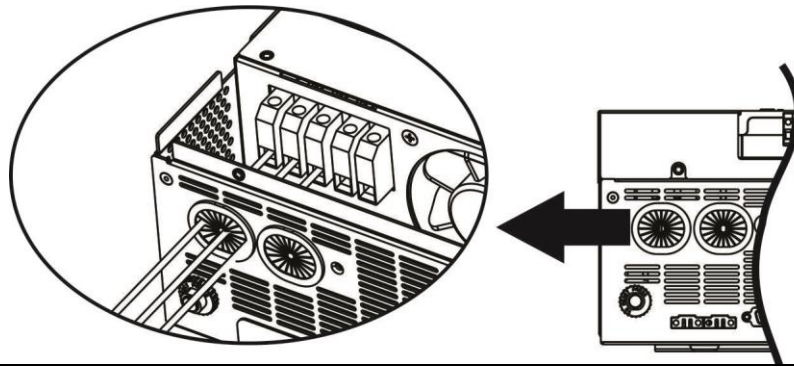

WARNING: Be sure that AC power source is disconnected before attempting to hardwire it to the unit.

4. Then, insert AC output wires according to polarities indicated on terminal block and tighten terminal screws. Be sure to connect PE protective conductor (⊕) first.

⊕ → **Ground (yellow-green)**

L → **LINE (brown or black)**

N → **Neutral (blue)**

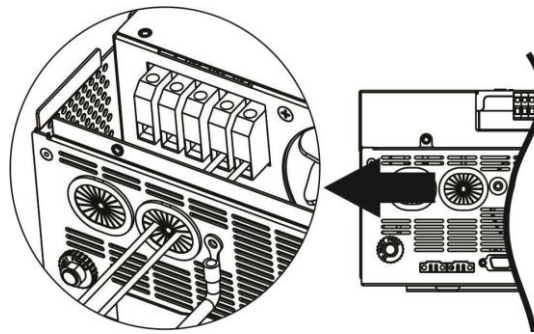

5. Make sure the wires are securely connected.

CAUTION: Important
Be sure to connect AC wires with correct polarity. If L and N wires are connected reversely, it may cause utility short-circuited when these inverters are worked in parallel operation.

CAUTION: Appliances such as air conditioner are required at least 2~3 minutes to restart because it's required to have enough time to balance refrigerant gas inside of circuits. If a power shortage occurs and recovers in a short time, it will cause damage to your connected appliances. To prevent this kind of damage, please check manufacturer of air conditioner if it's equipped with time-delay function before installation. Otherwise, this inverter/charger will trig overload fault and cut off output to protect your appliance but sometimes it still causes internal damage to the air conditioner.

PV Connection

CAUTION: Before connecting to PV modules, please install **separately** a DC circuit breaker between inverter and PV modules.

WARNING! All wiring must be performed by a qualified personnel.

WARNING! It's very important for system safety and efficient operation to use appropriate cable for PV module connection. To reduce risk of injury, please use the proper recommended cable size as below.

Model	Typical Amperage	Cable Size	Torque
3KW	60A	6 AWG	1.2~1.6 Nm
5KW	80A		

PV Module Selection:

When selecting proper PV modules, please be sure to consider below parameters:

1. Open circuit Voltage (Voc) of PV modules not exceeds max. PV array open circuit voltage of inverter.
2. Open circuit Voltage (Voc) of PV modules should be higher than min. battery voltage.

Solar Charging Mode		
INVERTER MODEL	3KW	5KW
Max. PV Array Open Circuit Voltage	145Vdc	
PV Array MPPT Voltage Range	30~115Vdc	60~115Vdc

Please follow below steps to implement PV module connection:

1. Remove insulation sleeve 10 mm for positive and negative conductors.
2. Check correct polarity of connection cable from PV modules and PV input connectors. Then, connect positive pole (+) of connection cable to positive pole (+) of PV input connector. Connect negative pole (-) of connection cable to negative pole (-) of PV input connector.

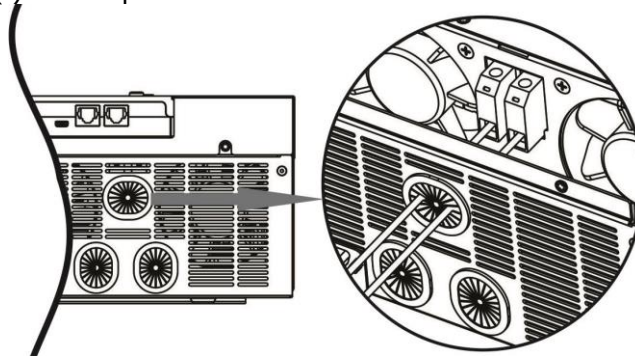
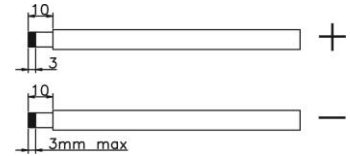

3. Make sure the wires are securely connected.

Final Assembly

After connecting all wirings, please put bottom cover back by screwing two screws as shown on the right chart.

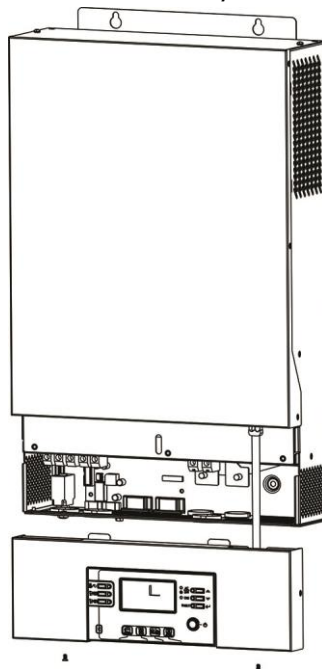

Remote Display Panel Installation

The LCD panel can be removable and installed in a remote site with an optional communication cable. Please follow below steps to implement this remote panel installation.

Step 1. Loosen the screw on the two sides of bottom case and push up the case cover. Then, remove screw on the top of the display panel. Now, the display can be removed from the bottom case. Then, pull out the cable from the remote communication port.

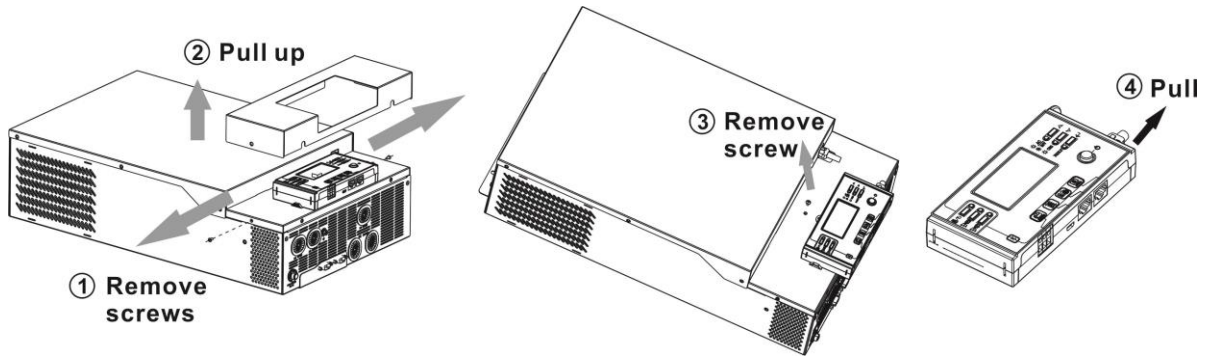

Step 2. Drill two holes in the marked locations with two screws as shown below chart. Place the panel on the surface and align the mounting holes with the two screws. Then, use one more screw on the top to fix the panel to the wall and check if the remote panel is firmly secured.

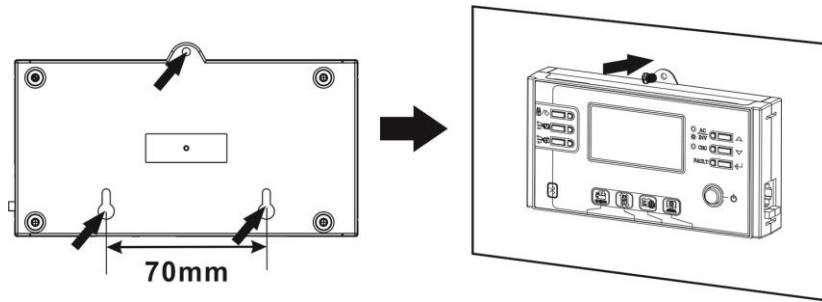

Note: Installation to the wall should be implemented with the proper screws. Refer chart for recommended spec of screws.

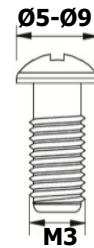

Step 3. Connect LCD panel to the inverter with an optional RJ45 communication cable as below chart.

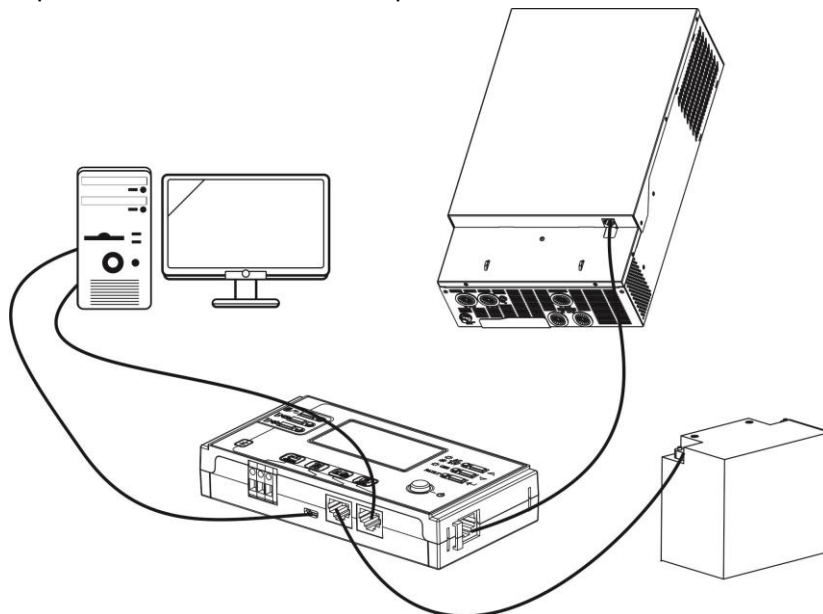

Communication Connection

Serial Connection

Please use supplied communication cable to connect to inverter and PC. Insert bundled CD into a computer and follow on-screen instruction to install the monitoring software. For the detailed software operation, please check user manual of software inside of CD.

Bluetooth Connection

This series is built in Bluetooth technology. You may simply go to google play to install "WatchPower". It allows wireless communication up to 6~7m in an open space.



Dry Contact Signal

There is one dry contact (3A/250VAC) available on the rear panel. It could be used to deliver signal to external device when battery voltage reaches warning level.

Unit Status	Condition		Dry contact port: 		
			NC & C	NO & C	
Power Off	Unit is off and no output is powered.		Close	Open	
Power On	Output is powered from Utility.		Close	Open	
	Output is powered from Battery power or Solar energy.	Program 01 set as USB (utility first)	Battery voltage < Low DC warning voltage	Open	Close
			Battery voltage > Setting value in Program 13 or battery charging reaches floating stage	Close	Open
	Output is powered from Battery power or Solar energy.	Program 01 is set as SBU (SBU priority) or SUB (solar first)	Battery voltage < Setting value in Program 12	Open	Close
Battery voltage > Setting value in Program 13 or battery charging reaches floating stage			Close	Open	

OPERATION

Power ON/OFF

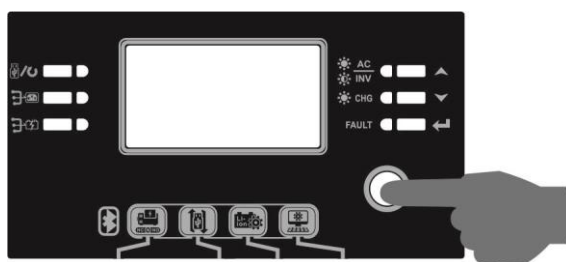

Once the unit has been properly installed and the batteries are connected well, simply press On/Off switch (located on the button of the case) to turn on the unit.

Operation and Display Panel

The operation and display panel, shown in below chart, is on the front panel of the inverter. It includes three indicators, four function keys and a LCD display, indicating the operating status and input/output power information.

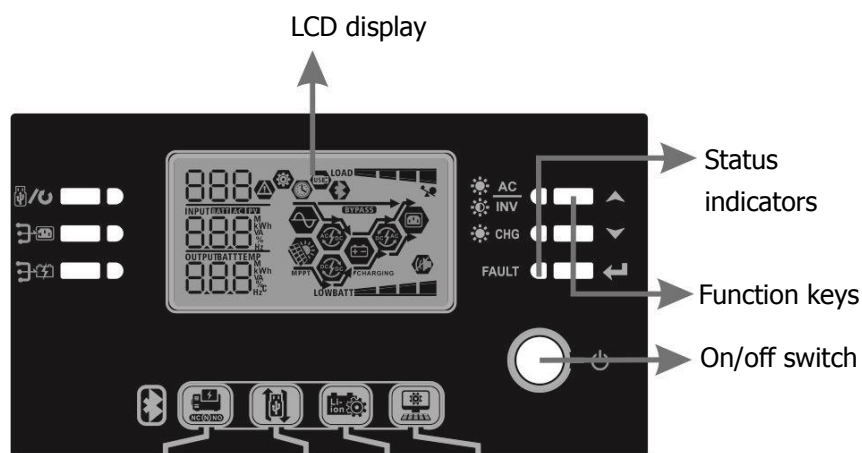

Indicators

LED Indicator		Color	Solid/Flashing	Messages
Status indicators		Green	Solid On	Output is available in bypass mode
			Flashing	Output is powered by battery in inverter mode
		Green	Solid On	Battery is fully charged
			Flashing	Battery is charging.
FAULT	Red	Solid On	Fault mode	
		Flashing	Warning mode	

Function Keys

Function Key	Description
	Exit the setting
	To last selection
	To next selection
	To confirm/enter the selection in setting mode

LCD Display Icons

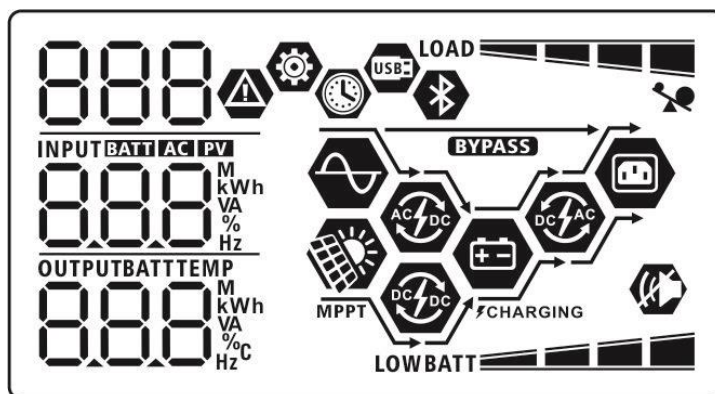





Icon	Function description	
Input Source Information		
	Indicates the AC input.	
	Indicates the PV input	
	Indicate input voltage, input frequency, PV voltage, charger current, charger power, battery voltage.	
Configuration Program and Fault Information		
	Indicates the setting programs.	
	Indicates the warning and fault codes. Warning: flashing with warning code. Fault: lighting with fault code	
Output Information		
	Indicate output voltage, output frequency, load percent, load in VA, load in Watt and discharging current.	
Battery Information		
	Indicates battery level by 0-24%, 25-49%, 50-74% and 75-100% in battery mode and charging status in line mode.	
In AC mode, it will present battery charging status.		
Status	Battery voltage	LCD Display
Constant Current mode / Constant Voltage mode	<2V/cell	4 bars will flash in turns.
	2 ~ 2.083V/cell	Bottom bar will be on and the other three bars will flash in turns.
	2.083 ~ 2.167V/cell	Bottom two bars will be on and the other two bars will flash in turns.
	> 2.167 V/cell	Bottom three bars will be on and the top bar will flash.
Floating mode. Batteries are fully charged.		4 bars will be on.
In battery mode, it will present battery capacity.		
Load Percentage	Battery Voltage	LCD Display
Load > 50%	< 1.85V/cell	LOW BATT
	1.85V/cell ~ 1.933V/cell	BATT
	1.933V/cell ~ 2.017V/cell	BATT
	> 2.017V/cell	BATT
Load < 50%	< 1.892V/cell	LOW BATT













	1.892V/cell ~ 1.975V/cell	BATT
	1.975V/cell ~ 2.058V/cell	BATT
	> 2.058V/cell	BATT
Load Information		
	Indicates overload.	
 	Indicates the load level by 0-24%, 25-49%, 50-74% and 75-100%.	
	0%~24%	25%~49%
	LOAD	LOAD
	50%~74%	75%~100%
	LOAD	LOAD
Mode Operation Information		
	Indicates unit connects to the mains.	
	Indicates unit connects to the PV panel.	
BYPASS	Indicates load is supplied by utility power.	
	Indicates the utility charger circuit is working.	
	Indicates the solar charger circuit is working.	
	Indicates the DC/AC inverter circuit is working.	
	Indicates unit alarm is disabled.	
	Indicates Bluetooth is connected.	
	Time display page	













LCD Setting









After pressing and holding “←” button for 3 seconds, the unit will enter setting mode. Press “▲” or “▼” button to select setting programs. And then, press “←” button to confirm the selection or “⏏/↺” button to exit.











Setting Programs:









Program	Description	Selectable option
00	Exit setting mode	Escape 00  ESC
01	Output source priority: To configure load power source priority	USB : Utility first (default) 01  USB Utility will provide power to the loads as first priority. If Utility energy is unavailable, solar energy and battery provides power the loads.
		SUB: Solar first 01  SUB Solar energy provides power to the loads as first priority. If solar energy is not sufficient to power all connected loads, utility energy will supply power to the loads at the same time. Battery provides power to the loads only when solar and utility is not sufficient.
		SBU priority 01  SBU Solar energy provides power to the loads as first priority. If solar energy is not sufficient to power all connected loads, battery energy will supply power to the loads at the same time. Utility provides power to the loads only when battery voltage drops to either low-level warning voltage or the setting point in program 12 or solar and battery is not sufficient.

02	Maximum charging current: To configure total charging current for solar and utility chargers. (Max. charging current = utility charging current + solar charging current)	60A (default) 02  60 ^A	3KW model setting range is from 10A to 120A and increment of each click is 10A. 5KW model setting range is from 10A to 140A and increment of each click is 10A.
05	Battery type	AGM (default) 05  AGM User-Defined 05  USE	Flooded 05  FLD If "User-Defined" is selected, battery charge voltage and low DC cut-off voltage can be set up in program 26, 27 and 29.
06	Auto restart when overload occurs	Restart disable (default) 06  LFD	Restart enable 06  LFE
07	Auto restart when over temperature occurs	Restart disable (default) 07  tFd	Restart enable 07  tFE
09	Output frequency	50Hz (default) 09  50 _{Hz}	60Hz 09  60 _{Hz}
10	Operation Logic	Automatically (default) 10  AUT Online mode 10  ONL	If selected and utility is available, inverter will work in line mode. Once utility frequency is unstable, inverter will work in bypass mode if bypass function is not forbidden in program 23. If selected, inverter will work in line mode when utility is available.

		ECO Mode 10  ECO	If selected and bypass is not forbidden in program 23, inverter will work in ECO mode when utility is available.
11	Maximum utility charging current Note: If setting value in program 02 is smaller than that in program in 11, the inverter will apply charging current from program 02 for utility charger.	2A 11  2 ^A	10A 11  10 ^A
		20A 11  20 ^A	30A (default) 11  30 ^A
		40A 11  40 ^A	50A 11  50 ^A
		60A 11  60 ^A	
12	Setting voltage point back to utility source when selecting "SBU" (SBU priority) or "SUB" (Solar first) in program 01	3KW default setting: 23.0V 12  23.0 ^{BATT} _v	5KW default setting: 46.0V 12  46.0 ^{BATT} _v
		3KW model setting range is from 22.0V to 28.5V and increment of each click is 0.5V. 5KW model setting range is from 44.0V to 57.0V and increment of each click is 1.0V.	
13	Setting voltage point back to battery mode when selecting "SBU" (SBU priority) or "SUB" (Solar first) in program 01	3KW model: The setting range is from 24.0V to 32.0V and increment of each click is 0.5V.	
		Battery fully charged 13  FUL ^{BATT}	27.0V (default) 13  27.0 ^{BATT} _v

13	Setting voltage point back to battery mode when selecting "SBU" (SBU priority) or "SUB" (Solar first) in program 01	5KW model: The setting range is from 48.0V to 64.0V and increment of each click is 1.0V.	
		Battery fully charged 13  BATT FUL	54.0V (default) 13  BATT 540 _v
16	Solar energy priority: To configure solar energy priority for battery and load	SbL: Solar energy for battery first UCB: Allow utility to charge battery (Default) 16  SbL UCb	Solar energy charges battery first and allow the utility to charge battery.
		SbL: Solar energy for battery first UdC: Disallow utility to charge battery 16  SbL UdC	Solar energy charge battery first and disallow the utility to charge battery.
		SLb: Solar energy for load first UCb: Allow utility to charge battery 16  SLb UCb	Solar energy provides power to the load first and also allow the utility to charge battery.
		SLb: Solar energy for load first UdC: Disallow utility to charge battery 16  SLb UdC	Solar energy provides power to the load first and disallow the utility to charge battery.
18	Alarm control	Alarm on (default) 18  60n	Alarm off 18  60F

19	Auto return to default display screen	Return to default display screen (default) 19  ESP	If selected, no matter how users switch display screen, it will automatically return to default display screen (Input voltage /output voltage) after no button is pressed for 1 minute.
		Stay at latest screen 19  HEP	If selected, the display screen will stay at latest screen user finally switches.
20	Backlight control	Backlight on (default) 20  LON	Backlight off 20  LOF
		Alarm on (default) 22  AON	Alarm off 22  AOF
23	Bypass function:	Bypass Forbidden 23  BYF	If selected, inverter won't work in bypass/ECO modes.
		Bypass disable 23  BYD	If selected and power ON button is pressed on, inverter can work in bypass/ECO mode only if utility is available.
		Bypass enable (default) 23  BYE	If selected and no matter power ON button is pressed on or not, inverter can work in bypass mode if utility is available.
25	Record Fault code	Record enable 25  FEN	Record disable (default) 25  FDS

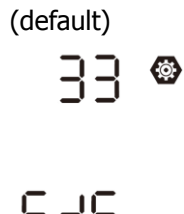
26	Bulk charging voltage (C.V voltage)	3KW default setting: 28.2V 	5KW default setting: 56.4V 
		If self-defined is selected in program 5, this program can be set up. Setting range is from 24.0V to 32.0V for 3KW model and 48.0V to 64.0V for 5KW model. Increment of each click is 0.1V.	
27	Floating charging voltage	3KW default setting: 27.0V 	5KW default setting: 54.0V 
		If self-defined is selected in program 5, this program can be set up. Setting range is from 24.0V to 32.0V for 3KW model and 48.0V to 64.0V for 5KW model. Increment of each click is 0.1V.	
29	Low DC cut-off voltage	3KW default setting: 21.0V 	5KW default setting: 42.0V 
		If self-defined is selected in program 5, this program can be set up. Setting range is from 20.0V to 27.0V for 3KW model and 40.0V to 54.0V for 5KW model. Increment of each click is 0.1V. Low DC cut-off voltage will be fixed to setting value no matter what percentage of load is connected.	
32	Bulk charging time	auto-charging time (default) 	5min 
		If "User-Defined" is selected in program 05, this program can be set up. Setting range is from 5min to 900min. Increment of each click is 5min. Otherwise, Keeping auto-charging time.	
33	Battery equalization	Battery equalization enable 	Battery equalization disable (default) 
		If "Flooded" or "User-Defined" is selected in program 05, this program can be set up.	

34	Battery equalization voltage	3KW default setting: 29.2V 34 EV BATT 29.2 _v	5KW default setting: 58.4V 34 EV BATT 58.4 _v
		Setting range is from 24.0V to 32.0V for 3KW model and 48.0V to 64.0V for 5KW model. Increment of each click is 0.1V.	
35	Battery equalized time	60min (default) 35 60	Setting range is from 5min to 900min. Increment of each click is 5min.
		120min (default) 36 120	Setting range is from 5min to 900 min. Increment of each click is 5 min.
37	Equalization interval	30days (default) 37 30d	Setting range is from 0 to 90 days. Increment of each click is 1 day
		Disable (default) 39 AdS	Enable 39 AEN
39	Equalization activated immediately	If equalization function is enabled in program 33, this program can be set up. If "Enable" is selected in this program, it's to activate battery equalization immediately and LCD main page will shows "EQ". If "Disable" is selected, it will cancel equalization function until next activated equalization time arrives based on program 37 setting. At this time, "EQ" will not be shown in LCD main page.	
40	Reset PV and Load energy storage	Not reset(Default) 40 Nrt	Reset 40 rst

95	Time setting – Minute		For minute setting, the range is from 00 to 59.
96	Time setting – Hour		For hour setting, the range is from 00 to 23.
97	Time setting– Day		For day setting, the range is from 00 to 31.
98	Time setting– Month		For month setting, the range is from 01 to 12.
99	Time setting – Year		For year setting, the range is from 17 to 99.

Display Setting

The LCD display information will be switched in turns by pressing "▲" or "▼" button. The selectable information is switched as below order: input voltage, input frequency, PV voltage, charging current, charging power, battery voltage, output voltage, output frequency, load percentage, load in Watt, load in VA, load in Watt, DC discharging current, main CPU Version.

Selectable information	LCD display
Input voltage/Output voltage (Default Display Screen)	<p>Input Voltage=230V, output voltage=230V</p>
Input frequency	<p>Input frequency=50Hz</p>
PV voltage	<p>PV voltage=80V</p>
PV current	<p>PV current = 2.5A</p>
PV power	<p>PV power = 500W</p>

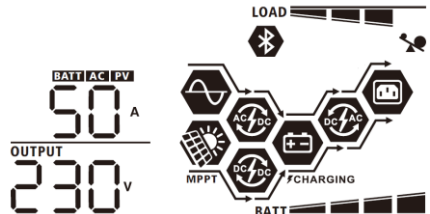
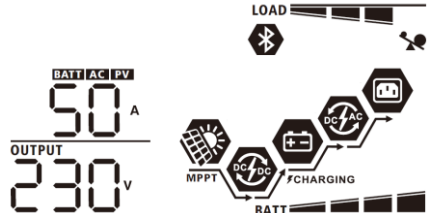
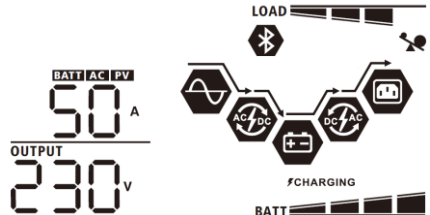
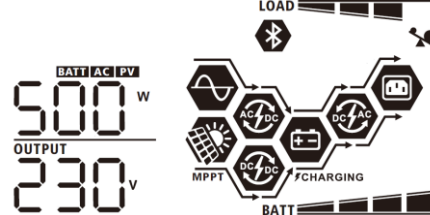
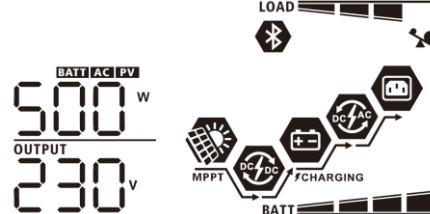
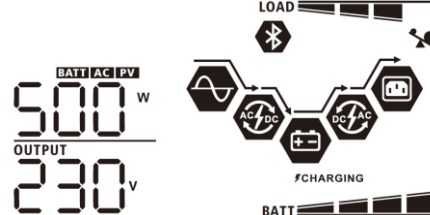
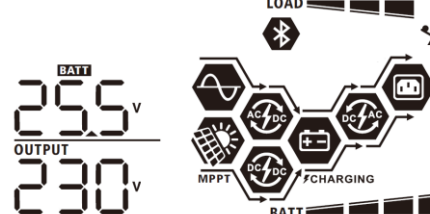

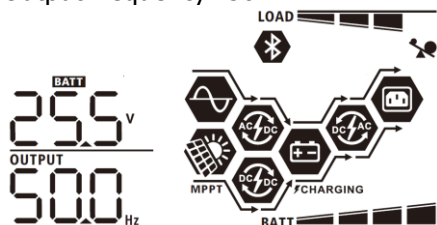
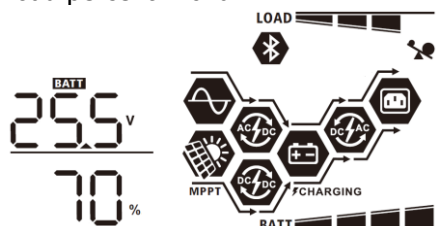
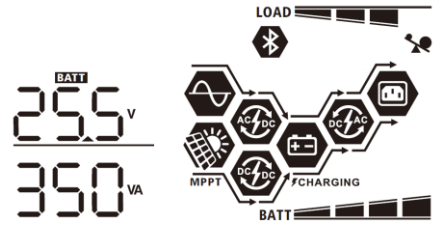
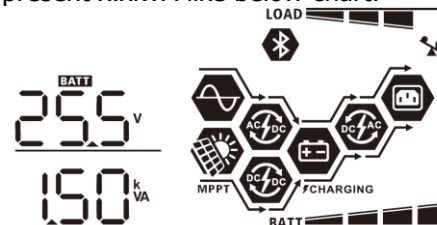
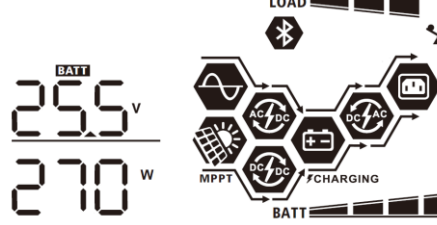
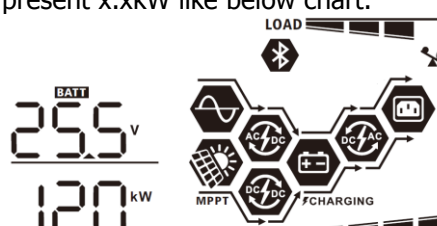
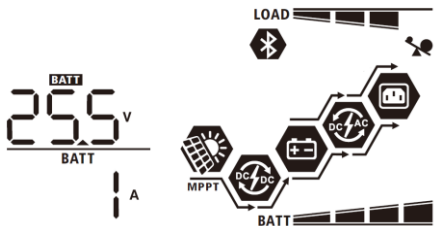

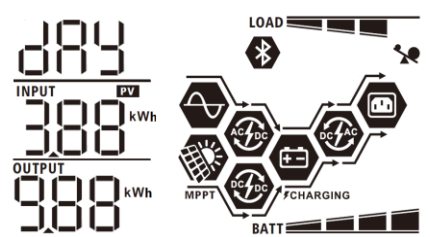
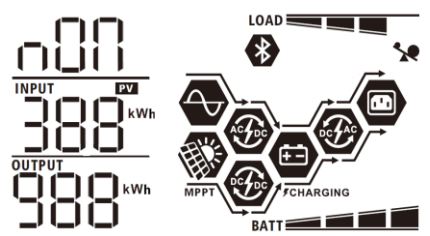
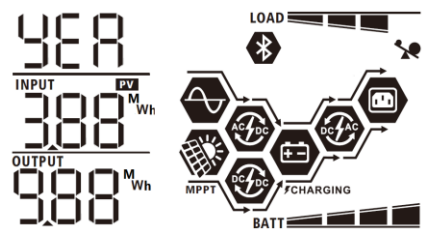
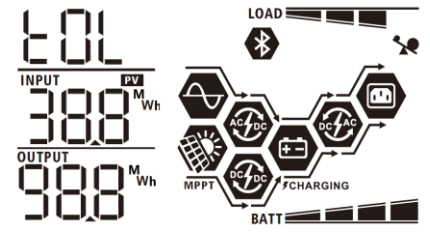
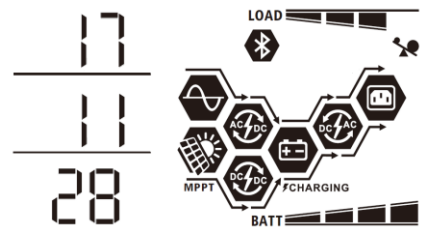
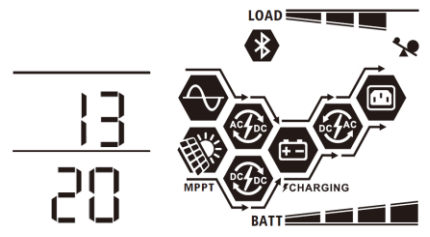

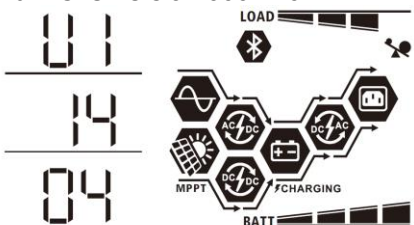
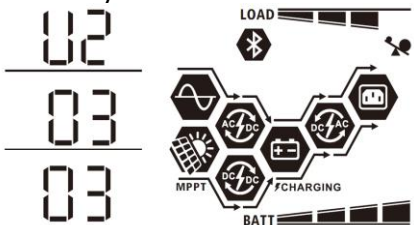
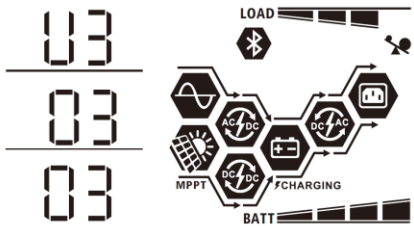
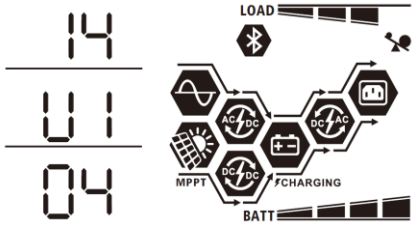
<p>Charging current</p>	<p>AC and PV charging current=50A</p>  <p>PV charging current=50A</p>  <p>AC charging current=50A</p> 
<p>Charging power</p>	<p>AC and PV charging power=500W</p>  <p>PV charging power=500W</p>  <p>AC charging power=500W</p> 
<p>Battery voltage and output voltage</p>	<p>Battery voltage=25.5V, output voltage=230V</p> 



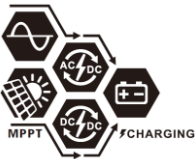

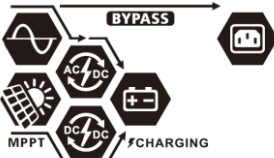
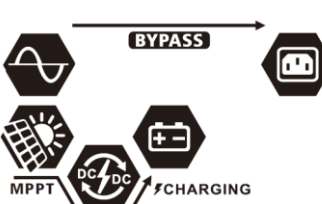

<p>Output frequency</p>	<p>Output frequency=50Hz</p>  <p>25.5 V OUTPUT 50.0 Hz</p>
<p>Load percentage</p>	<p>Load percent=70%</p>  <p>25.5 V 70 %</p>
<p>Load in VA</p>	<p>When connected load is lower than 1kVA, load in VA will present xxxVA like below chart.</p>  <p>25.5 V 350 VA</p> <p>When load is larger than 1kVA ($\geq 1\text{kVA}$), load in VA will present x.xxkVA like below chart.</p>  <p>25.5 V 150 kVA</p>
<p>Load in Watt</p>	<p>When load is lower than 1kW, load in W will present xxxW like below chart.</p>  <p>25.5 V 270 W</p> <p>When load is larger than 1kW ($\geq 1\text{kW}$), load in W will present x.xkW like below chart.</p>  <p>25.5 V 120 kW</p>
<p>Battery voltage/DC discharging current</p>	<p>Battery voltage=25.5V, discharging current=1A</p>  <p>25.5 V BATT 1 A</p>

<p>PV energy generated today and Load output energy today</p>	<p>PV energy generated Today = 3.88kWh, Load output energy Today = 9.88kWh.</p> 
<p>PV energy generated this month and Load output energy this month.</p>	<p>PV energy generated this month = 388kWh, Load output energy this month = 988kWh.</p> 
<p>PV energy generated this year and Load output energy this year.</p>	<p>PV energy generated this year energy = 3.88MWh, Load output energy this year = 9.88MWh.</p> 
<p>PV energy generated totally and Load output total energy.</p>	<p>Total PV energy until now= 38.8MWh, Total load output energy until now= 98.8MWh.</p> 
<p>Real date.</p>	<p>Real date Nov 28, 2017.</p> 
<p>Real time.</p>	<p>Real time 13:20.</p> 

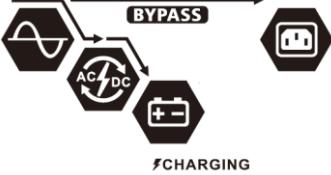
<p>Main CPU version checking.</p>	<p>Main CPU version 00014.04.</p>  <p>The display shows the version number 01.14.04 in a 7-segment font. To the right is a schematic diagram of the power system with components labeled: LOAD, MPPT, AC/DC, DC/DC, FCHARGING, DC/AC, and BATT. A Bluetooth icon is also present.</p>
<p>Secondary CPU version checking.</p>	<p>Secondary CPU version 00003.03.</p>  <p>The display shows the version number 02.03.03 in a 7-segment font. To the right is a schematic diagram of the power system with components labeled: LOAD, MPPT, AC/DC, DC/DC, FCHARGING, DC/AC, and BATT. A Bluetooth icon is also present.</p>
<p>Bluetooth version checking.</p>	<p>Bluetooth version 00003.03.</p>  <p>The display shows the version number 03.03.03 in a 7-segment font. To the right is a schematic diagram of the power system with components labeled: LOAD, MPPT, AC/DC, DC/DC, FCHARGING, DC/AC, and BATT. A Bluetooth icon is also present.</p>
<p>SCC version checking</p>	<p>SCC version 00003.03.</p>  <p>The display shows the version number 14.01.04 in a 7-segment font. To the right is a schematic diagram of the power system with components labeled: LOAD, MPPT, AC/DC, DC/DC, FCHARGING, DC/AC, and BATT. A Bluetooth icon is also present.</p>

Operating Mode Description

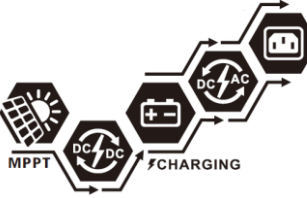









Operation mode	Description	LCD display
<p>Standby mode</p> <p>Note:</p> <p>*Standby mode: The inverter is not turned on yet but at this time, the inverter can charge battery without AC output.</p>	<p>No output is supplied by the unit but it still can charge batteries.</p>	<p>Charging by utility and PV energy.</p> 
		<p>Charging by utility.</p> 
		<p>Charging by PV energy.</p> 
		<p>No charging.</p> 
<p>Fault mode</p> <p>Note:</p> <p>*Fault mode: Errors are caused by inside circuit error or external reasons such as over temperature, output short circuited and so on.</p>	<p>Utility can bypass.</p>	<p>No charging and Bypass</p> 
		<p>No charging</p> 
<p>Bypass/ECO Mode</p>	<p>The unit will provide output power from the utility. PV energy and utility can charge batteries.</p>	<p>Charging by utility and PV energy.</p> 
		<p>Charging by PV</p> 

<p>Bypass/ECO Mode</p>	<p>The unit will provide output power from the utility. PV energy and utility can charge batteries.</p>	<p>Charging by utility</p> 
<p>Line Mode</p>	<p>The unit will provide output power from the mains. It will also charge the battery at line mode.</p>	<p>No charging</p> 
<p>Battery Mode</p>	<p>The unit will provide output power from battery and PV power.</p>	<p>Charging by utility and PV energy.</p> 
<p>Battery Mode</p>	<p>The unit will provide output power from battery and PV power.</p>	<p>Charging by utility.</p> 
<p>Battery Mode</p>	<p>The unit will provide output power from battery and PV power.</p>	<p>Power from battery and PV energy.</p> 
<p>Battery Mode</p>	<p>The unit will provide output power from battery and PV power.</p>	<p>PV energy will supply power to the loads and charge battery at the same time.</p> 
<p>Battery Mode</p>	<p>The unit will provide output power from battery and PV power.</p>	<p>Power from battery only.</p> 

Fault Reference Code

Fault Code	Fault Event	Icon on
01	Fan is locked when inverter is off.	F01
02	Over temperature	F02
03	Battery voltage is too high	F03
04	Battery voltage is too low	F04
05	Output short circuited or over temperature is detected by internal converter components.	F05
06	Output voltage is too high.	F06
07	Overload time out	F07
08	Bus voltage is too high	F08
09	Bus soft start failed	F09
50	PFC over current	F50
51	OP over current	F51
52	Bus voltage is too low	F52
53	Inverter soft start failed	F53
55	Over DC voltage in AC output	F55
56	Battery is not connected	F56
57	Current sensor failed	F57
58	Output voltage is too low	F58
59	PV voltage is over limitation	F59

Warning Indicator

Warning Code	Warning Event	Audible Alarm	Icon flashing
01	Fan is locked when inverter is on.	Beep three times every second	01 
02	Over temperature	None	02 
03	Battery is over-charged	Beep once every second	03 
04	Low battery	Beep once every second	04 
07	Overload	Beep once every 0.5 second	07  
10	Output power derating	Beep twice every 3 seconds	10 
32	Communication interrupted	None	32 
E9	Battery equalization	None	E9 
6P	Battery is not connected	None	6P  

Battery Equalization

Equalization function is added into charge controller. It reverses the buildup of negative chemical effects like stratification, a condition where acid concentration is greater at the bottom of the battery than at the top. Equalization also helps to remove sulfate crystals that might have built up on the plates. If left unchecked, this condition, called sulfation, will reduce the overall capacity of the battery. Therefore, it's recommended to equalize battery periodically.

- **How to Apply Equalization Function**

You must enable battery equalization function in monitoring LCD setting program 33 first. Then, you may apply this function in device by either one of following methods:

1. Setting equalization interval in program 37.
2. Active equalization immediately in program 39.

- **When to Equalize**

In float stage, when the setting equalization interval (battery equalization cycle) is arrived, or equalization is active immediately, the controller will start to enter Equalize stage.

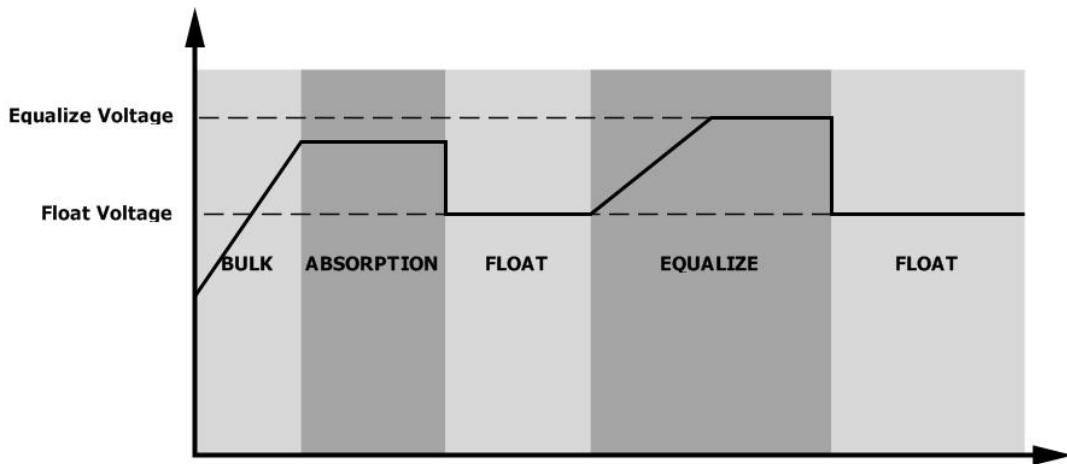

- **Equalize charging time and timeout**

In Equalize stage, the controller will supply power to charge battery as much as possible until battery voltage raises to battery equalization voltage. Then, constant-voltage regulation is applied to maintain battery voltage at the battery equalization voltage. The battery will remain in the Equalize stage until setting battery equalized time is arrived.

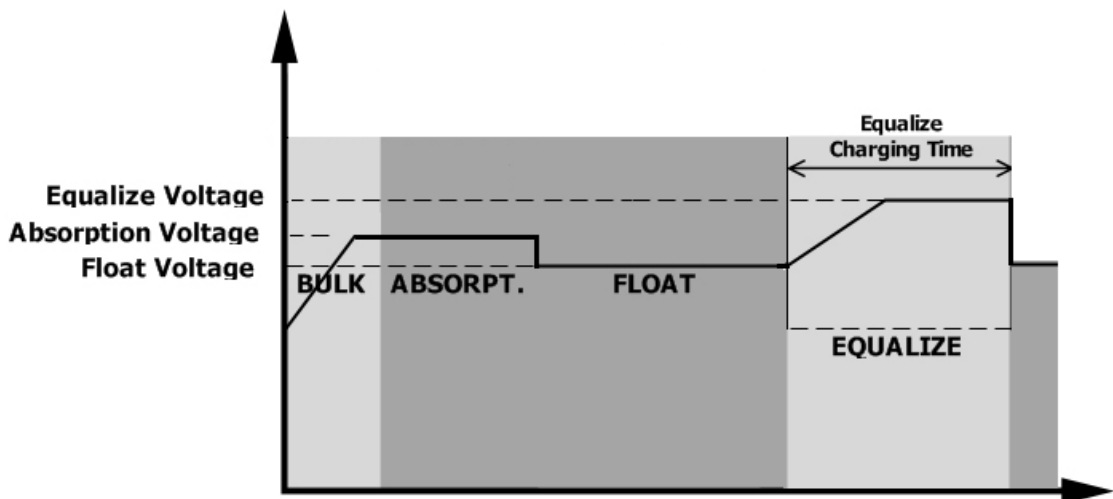

However, in Equalize stage, when battery equalized time is expired and battery voltage doesn't rise to battery equalization voltage point, the charge controller will extend the battery equalized time until battery voltage achieves battery equalization voltage. If battery voltage is still lower than battery equalization voltage when battery equalized timeout setting is over, the charge controller will stop equalization and return to float stage.

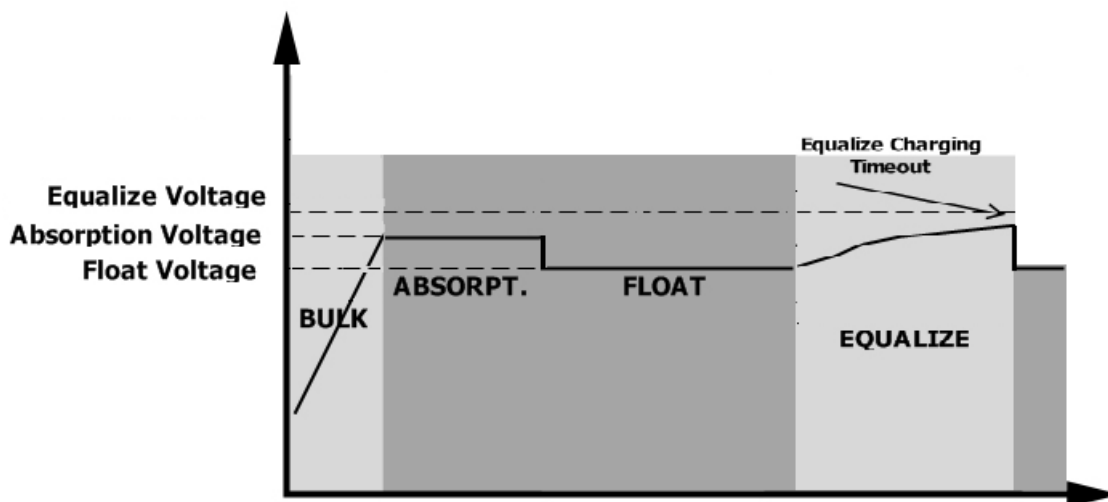

SPECIFICATIONS

Table 1 Line Mode Specifications

INVERTER MODEL	3KW	5KW
Input Voltage Waveform	Sinusoidal (utility or generator)	
Nominal Input Voltage	230Vac	
Low Loss Voltage	110Vac±7V	
Low Loss Return Voltage	120Vac±7V	
High Loss Voltage	280Vac±7V	
High Loss Return Voltage	270Vac±7V	
Max AC Input Voltage	300Vac	
Nominal Input Frequency	50Hz / 60Hz (Auto detection)	
Low Loss Frequency	46(56)±1Hz	
Low Loss Return Frequency	46.5(57)±1Hz	
High Loss Frequency	54(64)±1Hz	
High Loss Return Frequency	53(63)±1Hz	
Power Factor	>0.98	
Output Short Circuit Protection	Line mode: Circuit Breaker Battery mode: Electronic Circuits	
Efficiency (Line Mode)	93% (Peak Efficiency)	
Transfer Time	Line mode←→Battery mode 0ms Inverter←→Bypass 4ms	

Table 2 Battery Mode Specifications

INVERTER MODEL	3KW	5KW
Rated Output Power	3KVA/3KW	5KVA/5KW
Output Voltage Waveform	Pure Sine Wave	
Output Voltage Regulation	230Vac±5%	
Output Frequency	50Hz or 60Hz	
Peak Efficiency	90%	
Overload Protection	5s@≥150% load; 10s@105%~150% load	
Surge Capacity	2* rated power for 5 seconds	
Nominal DC Input Voltage	24Vdc	48Vdc
Operating Range	20Vdc -34Vdc	40Vdc -66Vdc
Cold Start Voltage	23Vdc	46Vdc
Low DC Warning Voltage @ load < 50% @ load ≥ 50%	22.5Vdc 22.0Vdc	45.0Vdc 44.0Vdc
Low DC Warning Return Voltage @ load < 50% @ load ≥ 50%	23.5Vdc 23.0Vdc	47.0Vdc 46.0Vdc
Low DC Cut-off Voltage @ load < 50% @ load ≥ 50%	21.5Vdc 21.0Vdc	43.0Vdc 42.0Vdc
High DC Recovery Voltage	32Vdc	64Vdc
High DC Cut-off Voltage	34Vdc	66Vdc
No Load Power Consumption	<75W	<75W

Table 3 Charge Mode Specifications

Utility Charging Mode			
INVERTER MODEL	3KW	5KW	
Charging Current @ Nominal Input Voltage	Default: 30A, max: 60A		
Bulk Charging Voltage	Flooded Battery	29.2Vdc	58.4Vdc
	AGM / Gel Battery	28.2Vdc	56.4Vdc
Floating Charging Voltage	27Vdc	54Vdc	
Overcharge Protection	34Vdc	66Vdc	
Charging Algorithm	3-Step		
Charging Curve			

Solar Charging Mode (MPPT type)		
INVERTER MODEL	3KW	5KW
Rated Power	1500W	4000W
Maximum charging current	60A	80A
Efficiency	98.0% max.	
Max. PV Array Open Circuit Voltage	145Vdc	
PV Array MPPT Voltage Range	30~115Vdc	60~115Vdc
Battery Voltage Accuracy	+/-0.3%	
PV Voltage Accuracy	+/-2V	
Charging Algorithm	3-Step	
Joint Utility and Solar Charging		
Max Charging Current	120A	140A
Default Charging Current	60A	

Table 4 ECO/Bypass Mode Specifications

Bypass Mode		
INVERTER MODEL	3KW	5KW
Input Voltage Waveform	Sinusoidal (utility or generator)	
Low Loss Voltage	176Vac±7V	
Low Loss Return Voltage	186Vac±7V	
High Loss Voltage	280Vac±7V	
High Loss Return Voltage	270Vac±7V	
Nominal Input Frequency	50Hz / 60Hz (Auto detection)	
Low Loss Frequency	46(56)±1Hz	
Low Loss Return Frequency	46.5(57)±1Hz	
High Loss Frequency	54(64)±1Hz	
High Loss Return Frequency	53(63)±1Hz	

Table 5 General Specifications

INVERTER MODEL	3KW	5KW
SCC type	MPPT	
Parallel-able	YES	
Communication	RS232 and Bluetooth	
Safety Certification	CE	
Operating Temperature Range	0°C to 55°C	
Storage temperature	-15°C~ 60°C	
Humidity	5% to 95% Relative Humidity (Non-condensing)	
Dimension (D*W*H), mm	140 x 303 x 525	
Net Weight, kg	13.0	13.5

TROUBLE SHOOTING

Problem	LCD/LED/Buzzer	Explanation / Possible cause	What to do
Unit shuts down automatically during startup process.	LCD/LEDs and buzzer will be active for 3 seconds and then complete off.	The battery voltage is too low (<1.91V/Cell)	1. Re-charge battery. 2. Replace battery.
No response after power on.	No indication.	1. The battery voltage is far too low. (<1.4V/Cell) 2. Battery polarity is connected reversed.	1. Check if batteries and the wiring are connected well. 2. Re-charge battery. 3. Replace battery.
Mains exist but the unit works in battery mode.	Input voltage is displayed as 0 on the LCD and green LED is flashing.	Input protector is tripped	Check if AC breaker is tripped and AC wiring is connected well.
	Green LED is flashing.	Insufficient quality of AC power. (Shore or Generator)	1. Check if AC wires are too thin and/or too long. 2. Check if generator (if applied) is working well or if input voltage range setting is correct. (UPS→Appliance)
	Green LED is flashing.	Set "Solar First" as the priority of output source.	Change output source priority to Utility first.
When the unit is turned on, internal relay is switched on and off repeatedly.	LCD display and LEDs are flashing	Battery is disconnected.	Check if battery wires are connected well.
Buzzer beeps continuously and red LED is on.	Fault code 07	Overload error. The inverter is overload 110% and time is up.	Reduce the connected load by switching off some equipment.
	Fault code 05	Output short circuited.	Check if wiring is connected well and remove abnormal load.
	Fault code 02	Internal temperature of inverter component is over 100°C.	Check whether the air flow of the unit is blocked or whether the ambient temperature is too high.
	Fault code 03	Battery is over-charged.	Return to repair center.
		The battery voltage is too high.	Check if spec and quantity of batteries are meet requirements.
	Fault code 01	Fan fault	Replace the fan.
	Fault code 06/58	Output abnormal (Inverter voltage below than 190Vac or is higher than 260Vac)	1. Reduce the connected load. 2. Return to repair center
	Fault code 08/09/53/57	Internal components failed.	Return to repair center.
	Fault code 50	PFC over current or surge.	Restart the unit, if the error happens again, please return to repair center.
	Fault code 51	OP over current or surge.	
	Fault code 52	Bus voltage is too low.	
	Fault code 55	Output voltage is unbalanced.	
Fault code 56	Battery is not connected well or fuse is burnt.	If the battery is connected well, please return to repair center.	

Appendix I: Approximate Back-up Time Table

Model	Load (VA)	Backup Time @24Vdc 200Ah (min)	Backup Time @24Vdc 400Ah (min)
3KW	300	898	2200
	600	444	1050
	900	249	606
	1200	190	454
	1500	136	328
	1800	112	252
	2100	96	216
	2400	70	188
	2700	62	148
	3000	56	134

Model	Load (VA)	Backup Time @ 48Vdc 200Ah (min)	Backup Time @ 48Vdc 400Ah (min)
5KW	500	1226	2576
	1000	536	1226
	1500	316	804
	2000	222	542
	2500	180	430
	3000	152	364
	3500	130	282
	4000	100	224
	4500	88	200
	5000	80	180

Note: Backup time depends on the quality of the battery, age of battery and type of battery.
Specifications of batteries may vary depending on different manufacturers.