



EIBENSTOCK

Elektrowerkzeuge



CATALOG

Professional power tools
Made in Germany



TODAY

Continous company expansion of buildings and equipment. More than 250 employees manufacture diamond core drilling technology, mixing technology and numerous machines for renovation / refurbishment.

2019

Company expansion
Opening of the new Training & Development Center and two new warehouses.



1993

Privatisation as „Elektrowerkzeuge GmbH Eibenstock“.



EIBENSTOCK
Elektrowerkzeuge

1990

First EIBENSTOCK stirrer.



1985

Lothar Lässig has been appointed as the new director.

1972

Nationalisation - Conversion to a state-owned company „VEB Elektrowerkzeugbau Eibenstock“.



1960

Development of the SBI/23 – the first impact drill of the GDR.



1952

Development of the Polisher P10 with the world novelty of a 60° gearbox .



1944

Destruction of the company building during World War II. The company moved to the mountain city Eibenstock.



1940

Horst Ditter, since 1940 co-owner and later director of „Hönnecke & Ditter KG / Eibenstock“.



1919

The Company was founded by Martin Hönnecke in Leipzig with specialisation in the power-tools branch.



Headquarters
EIBENSTOCK



Division II
Aluminium foundry
Steel parts production



Training and development center
EIBENSTOCK



Division III
Motor production



The company was founded in 1919 and from the start specialised in professional products for heavy construction site use. With this strategy, an above average growth has been reached over recent years. More than 90 % of all components are produced in the own facilities.

The employees proudly say, that the brand name EIBENSTOCK enjoys a good reputation amongst both industrial and building trade customers. The basis for this is formed through the connection of a long tradition with current development results, a well educated and skilled staff, latest manufacturing technology, an extensive quality assurance system and a creative development team under a dynamic management. There are continuously developed innovative products that are exported to more than 80 countries worldwide and that are leading in special product ranges.

The current product range includes manual drills, diamond core drills, drill rigs, stirres, wall chasers, concrete grinders, scouring machines, diamond saws, polishers, calenders, dry-wall sanders, dry-wall screwdrivers, smoothing machines for plaster and insulating boards, special power tools and drive motors.

Thanks to extensive investments in the area of motor and gearbox manufacturing, the company is able to meet the high standards in international competition, with a favourable price-performance ratio.

Convince yourself of our reliable products and our expertise.

POWER TOOLS FROM EIBENSTOCK 100 years quality products used in industry and craft trade

Elektrowerkzeuge GmbH Eibenstock
Auersbergstraße 10 · 08309 Eibenstock, Germany
Phone: +49 37752 503-0
Fax: +49 37752 2019
E-Mail: office@eibenstock.com · Internet: www.eibenstock.com



CUSTOMER SERVICE

Our products are exclusively available through qualified dealers, who can advise you on our vast range of products. Furthermore, our telephone Customer Service team, for technical questions, problems and solutions is available from 7.00 am to 4.30 pm, Monday to Thursday, and from 7.00 am to 3.30 pm on Friday. You can also send us your questions by Fax or E-mail. Our representatives will be more than happy to help.

Phone: +49 37752 503-0
Fax: +49 37752 2019
E-mail: office@eibenstock.com



CUSTOMER CONTACT

We look forward to speaking to our customers and users at a variety of National and International fairs, training days and on site. Our customer contact allows us to develop our products to the needs of the user and results in a high level of user friendliness as well as a significant saving on working time and thus cost.



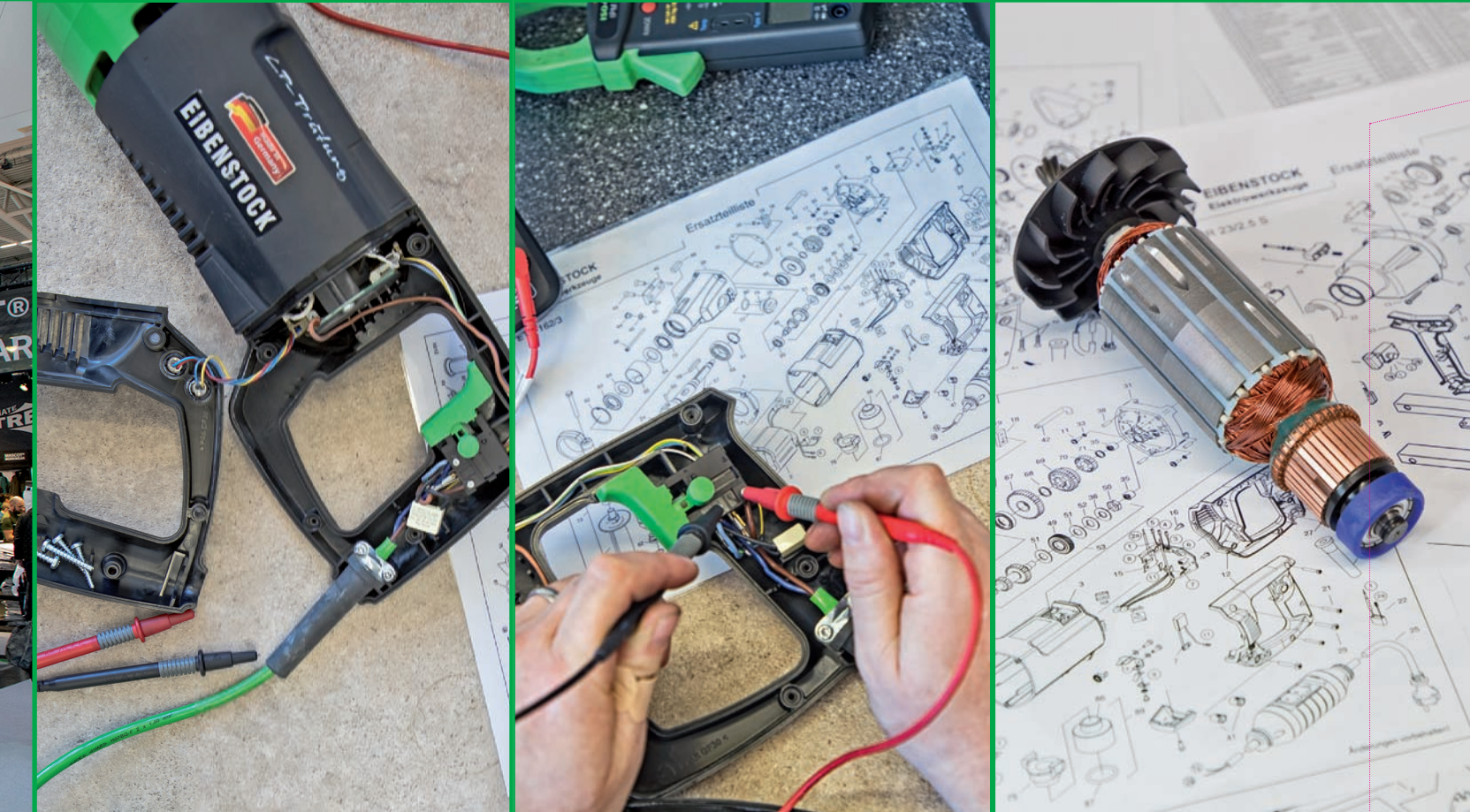

REPAIR SERVICE

We guarantee the continuous availability of all spare parts to our customers across the whole product range. We also promise to stock spare parts from discontinued products for at least 10 years. Our spares are widely available from your local EIBENSTOCK retailer, which are provided with full manufacturer's support. If you have any questions or need contact information please contact us on:

Phone: +49 37752 503-0 | Fax: +49 37752 2019

E-mail: reparaturservice@eibenstock.com

WARRANTY

All our power tools come with a one year warranty, as required by law. If you need to make a warranty claim, please send the repair, together with the proof of purchase to an authorised dealer.



VISIT US ON THE INTERNET:
EIBENSTOCK.COM





PROBLEM SOLUTIONS ALL AROUND THE CONSTRUCTION SITE

■ Sanding surfaces, milling/
redeveloping surfaces



■ Slitting of installation
channels



■ Assembly and sanding
of drywall installations

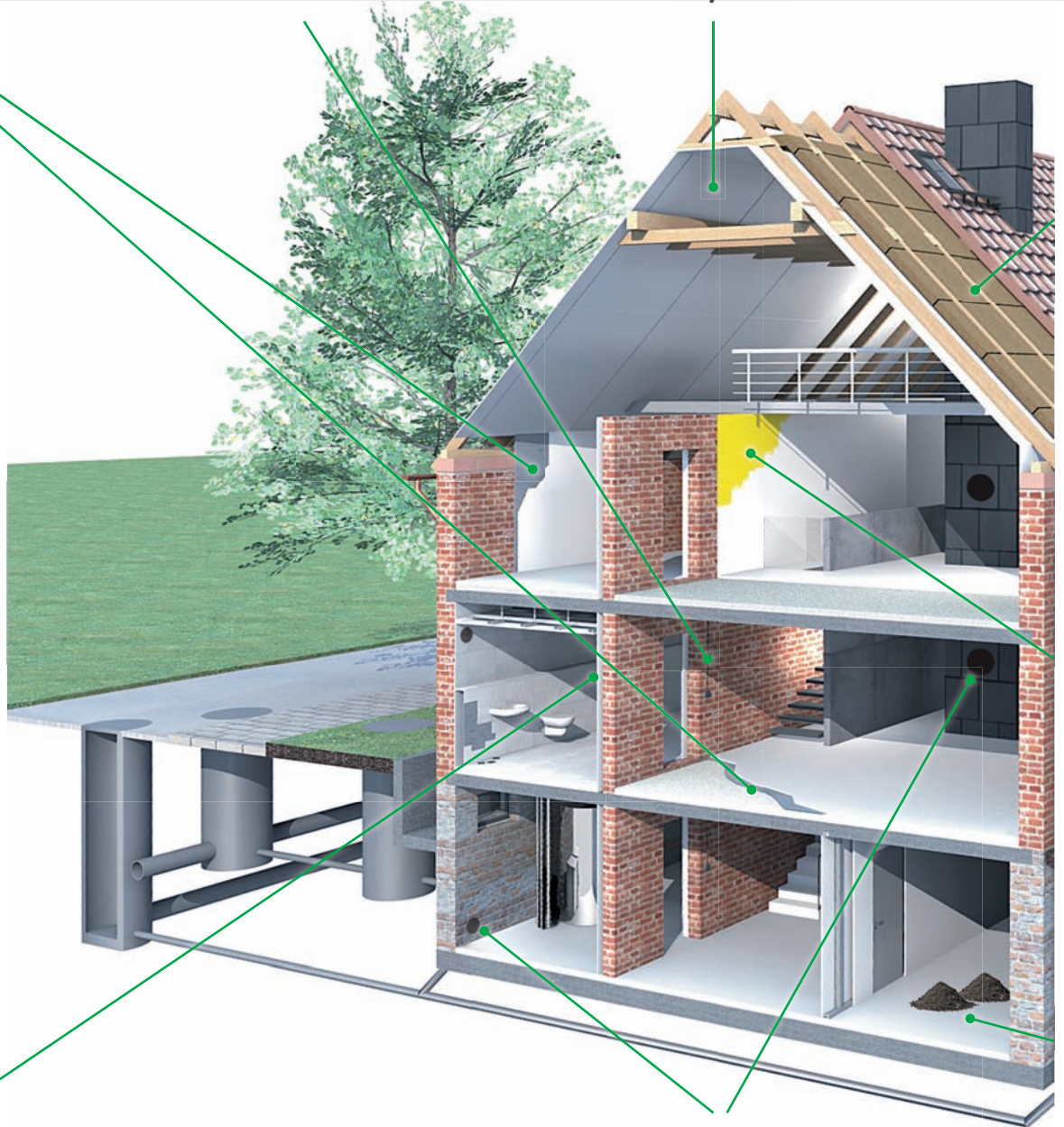

■ Drilling of tiles and slabs



■ Drilling/
installation openings



Drilling and screwing of wood and metal



Finishing of insulation material and facades



Polishing and sanding of surfaces

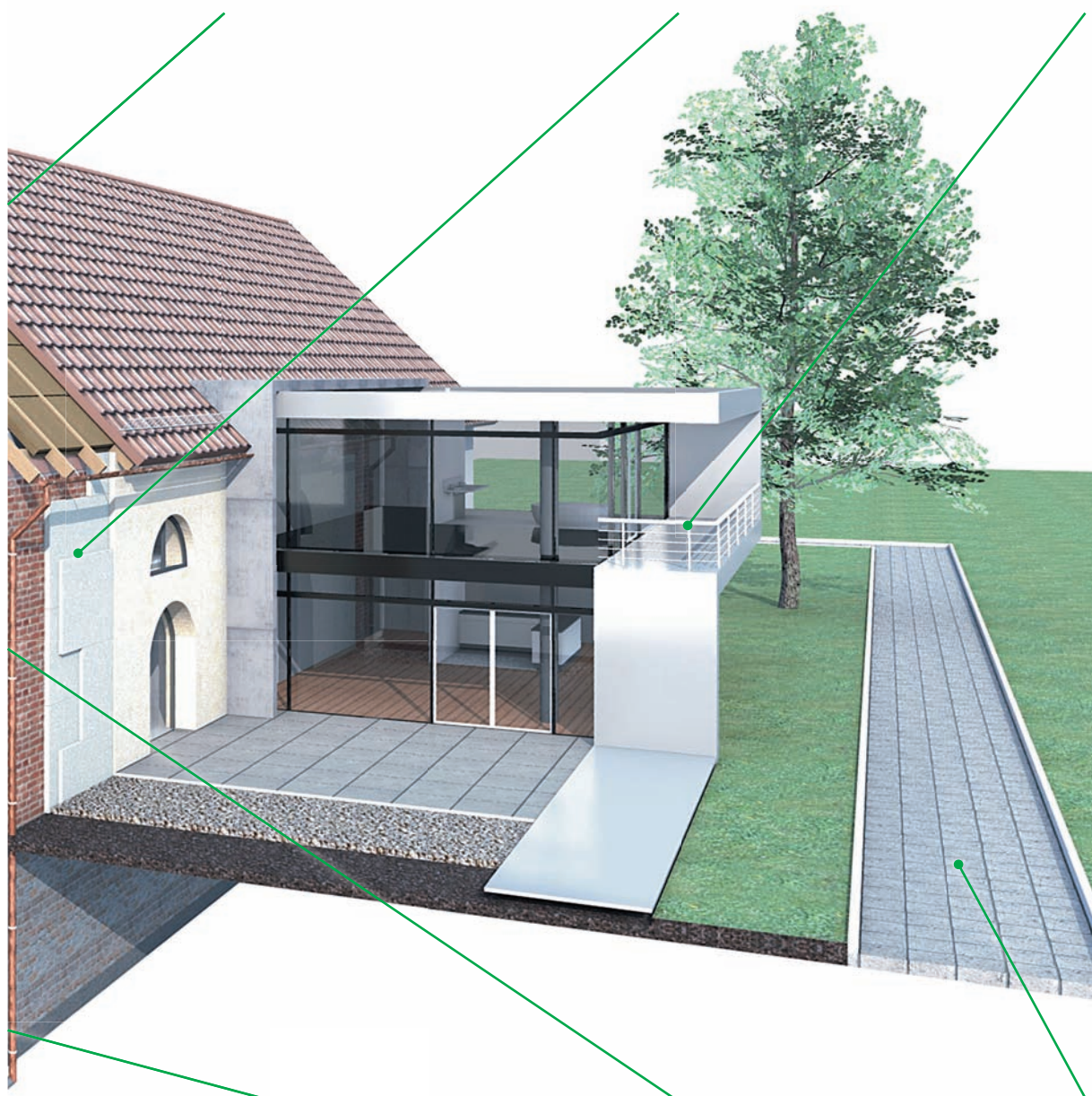

DESIGNED BY **Furoris gruppe** IN SAXONY

Pump- & Vacuuming of dust and mud/cleaning of the construction site



Mixing of material



Cutting of material





THE RIGHT MACHINE FOR THE USER

	Painter/ Stucco plasterer	Electrician	Tiler	Floor fitters	Sanitary, heating, ven- tilation construction	Chimney builder	Roofer/Carpenter	Gardening and lands- caping/Stonemason	Dry-wall installation	Civil engineering	Steel and metal construction	Drilling operation	Page
Drilling/Screwing													
EHB 16/1.4 S R/L							x				x		12
EHB 16/2.4 S R/L							x				x		12
EHB 20/2.4							x				x		13
EHB 32/2.2 R R/L							x				x		14
EHB 32/4.2							x				x		14
Dry-wall screwdriver ESR 450									x				15
Diamond dry core drills													
EHD 1500		x			x								22
EHD 2000 S		x			x								24
EHD 1801					x	x							26
ESD 1801		x			x								28
Diamond wet-dry core drills													
ETN 162/3		x			x	x				x		x	30
PLD 182.1 NT		x			x	x				x		x	32
Diamond wet core drills													
END 712 P			x		x			x		x	x		34
END 1550 P		x	x		x			x		x	x		36
Diamond core drilling units													
DBE 162		x			x	x				x		x	46
PLE 182		x			x	x				x		x	47
DB 201										x			48
DBE 182		x			x					x		x	49
DBE 250 R					x					x		x	50
DBE 352					x					x		x	51
PLE 450 B					x					x		x	52
Tile drilling machine EFB 68			x					x					56
Tile drilling machine EFB 152 PX			x					x					58
Mixing													
Stirrer EHR 14.1 SK Set	x		x	x		x			x				62
Stirrer EHR 15.2 SB Set	x		x	x		x				x			62
Stirrer EHR 18.1 S Set	x		x	x		x				x			63
Stirrer EHR 20.1 R Set	x		x	x		x		x		x			63
Stirrer EHR 20/2.6 S Set	x		x	x		x		x		x			64
Stirrer EHR 23/2.5 S Set	x			x				x		x			64
Stirrer EHM 162 S Set	x			x				x		x			65
Contra twin stirrer EZR 24 R R/L Set	x			x						x			65
Petrol stirrer EHR 750 B								x		x			66
Mixing station TwinMix 1800 T	x		x	x				x		x			70
Mixing station FloorMix 2300	x		x	x						x			72
Mixing station Automix 1801	x			x						x			74
Mixing station Automix 90	x			x						x			74

	Painter/ Stucco plasterer	Electrician	Tiler	Floor fitters	Sanitary, heating, ven- tilation construction	Chimney builder	Roofer/Carpenter	Gardening and lands- caping/Stonemason	Dry-wall installation	Civil engineering	Steel and metal construction	Drilling operation	Page
Sanding/Milling/Smoothing													
Scabblers and scouring machine EPF 1503	x		x	x						x			82
Concrete grinder EBS 120.1			x	x						x			83
Concrete grinder EBS 125.4 O			x	x						x			84
Concrete grinder EBS 125.4 RO			x	x						x			84
Concrete grinder EBS 1802			x	x						x			85
Concrete grinder EBS 1802 SH			x	x						x			85
Concrete grinder EBS 180 H			x	x						x			86
Concrete grinder EBS 180 F			x	x						x			87
Concrete grinder EBS 235.1			x	x						x			88
Long reach renovation grinder ELS 125 D	x		x							x			89
Surface milling machine EOF 100.1	x			x			x						92
Long reach sander ELS 225.1	x								x				94
Dry-wall sander ETS 225	x								x				95
Insulation board sander EWS 400	x									x			95
Plaster smoothing ma. EPG 400 A	x									x			96
Plaster smoothing ma. EPG 400	x									x			97
Plaster smoothing ma. EPG 400 WP	x									x			97
Sawing/Cutting/Slitting													
Diamond saw EDS 125			x					x					101
Cutting tables ETT 700/ETT 1200			x					x					103
Diamond saw EDS 181			x	x				x		x			104
Universal cutting saw EST 350.2								x		x			106
Cutting and grinding system ETR 230							x	x		x	x		107
Cutting systems ETR 350.1 P/ETR 400.1 P							x	x		x	x	x	108
Double blade sword saw EDB 480.1							x		x	x			110
Wall chaser EMF 125.2		x											112
Wall chaser EMF 150.1		x											113
Wall chaser EMF 180.2					x								114
Polishing/Calendering													
Polisher WPN 180			x					x					120
Calender ESM 1310/ESM 1311 Set							x				x		121
Pumping/Vacuuming													
Construction cleaner SS 1401 L	x	x	x	x	x	x	x	x	x	x	x	x	124
Industrial vacuum cleaner DSS 25 A	x	x	x	x	x	x	x	x	x	x	x	x	125
Industrial vacuum cleaner DSS 50 A	x	x	x	x	x	x	x	x	x	x	x	x	125
Industrial vacuum cleaner DSS 25 M	x	x	x	x	x	x	x	x	x	x	x	x	126
Industrial vacuum cleaner DSS 35 M iP	x	x	x	x	x	x	x	x	x	x	x	x	127
Pump vacuum cleaner EPS 50							x	x		x			128



DIRECTORY

Drilling/Screwing	9
Overview	10
Machines Drilling/Screwing	11-15
Accessories	16
Diamond core drilling	17
Overview	18-20
Diamond dry core drills and Accessories	22-29
Diamond wet-dry core drill and Accessories	30-33
Diamond wet core drills and Accessories	34-37
Core drill motors	38-39
Drill rigs	40-45
Diamond core drilling units	46-52
Diamond drill bits	53
Diamond core drilling units Accessories	54-55
Tile drilling machines	56-58
Mixing	59
Overview	60
Stirrers	61-68
Mixing stations	67-74
Stirring rods	75-77
Accessories	78
Sanding/Milling/Smoothing	79
Overview	80
Machines Sanding/Milling	81-89
Accessories Sanding/Milling	90-91
Machines Sanding/Milling/Smoothing	92-97
Accessories Sanding/Milling/Smoothing	98
Sawing/Cutting/Slitting	99
Overview	100
Machines Sawing/Cutting/Slitting	101-114
Accessories	114-115
Polishing/Calendering	117
Overview	118
Machines Polishing/Calendering	119-121
Accessories	122
Pump vacuuming/Vacuuming	123
Overview	124
Pump vacuum cleaner/Industrial vacuum cleaner	124-128
Accessories	129

DRILLING SCREWING





Model	Page	Max. drilling diameter	Spindle connection	Power input	Rated speed
DRILLING					
 EHB 16/1.4 S R/L 0121E000	12	 Wood 65 mm  Alu 28 mm  Steel 20 mm	5/8" x 16 UN	1150 W	0-450 rpm
 EHB 16/2.4 S R/L 0122H000	12	 Wood 65 mm  Alu 28 mm  Steel 20 mm	5/8" x 16 UN	1150 W	0-430/ 0-760 rpm
 EHB 20/2.4 0132A000	13	 Wood 70 mm  Alu 40 mm  Steel 20 mm	MT 2	1150 W	250/ 450 rpm
 EHB 32/2.2 R R/L 0152H000	14	 Wood 100 mm  Alu 60 mm  Steel 32 mm	MT 3	1800 W	60-140/ 200-470 rpm
 EHB 32/4.2 0154A000	14	 Wood 100 mm  Alu 60 mm  Steel 32 mm	MT 3	1700 W	110/175/ 245/385 rpm
SCREWING					
 ESR 450 06102000	15	 5 mm	1/4"	450 W	No-load speed 0-4000 rpm

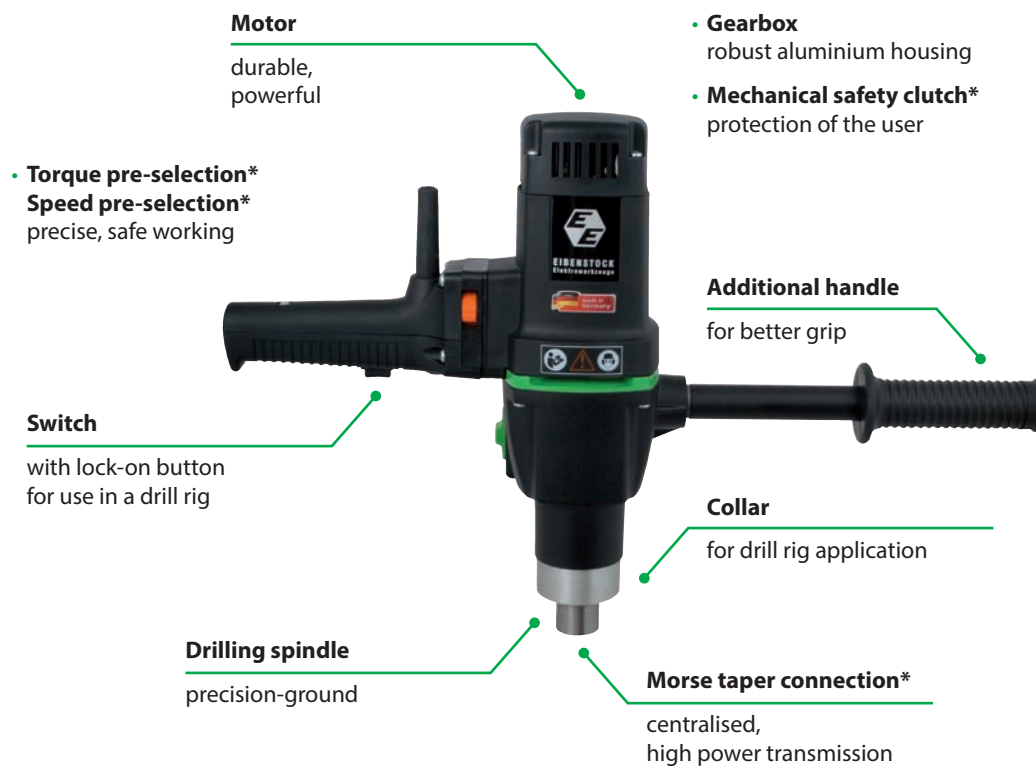

* not present on all models

FEATURES OF HAND-HELD DRILLING MACHINES

The EIBENSTOCK high performance hand-held drills are great for drilling steel, aluminium, plastic, hard and soft wood. All machines are robust and powerful for continuous use and high operational reliability.

EIBENSTOCK drilling machines are mainly used in the metal working and assembly industries as well as steel construction, machinery, plant and vehicles renovation and the carpentry and wood industries.



Hand-held drilling machine EHB 16/1.4 S R/L



Ø 20
in steel

1

Hand-held drilling machine EHB 16/2.4 S R/L



Ø 20
in steel

2

Compact models

APPLICATION:

- Drilling and screwing of wood, aluminium, steel
- Mobile for easy transport to site
- Metal and timber construction

FEATURES:

- Soft start speed control – precise drilling/screwing
- Reversible – easily remove of the drill bit from holes and easily screw in and remove screws
- High torque gearbox – powerful drilling
- Adjustable handle with aluminium clamp – allows adaptation to the application and working position
- Long front handle allowing for easy handling at high torque and optimal power transmission
- Spade handle – optimal power transmission



SPECIFICATIONS	EHB 16/1.4 S R/L
Power input	1150 W
Rated voltage	230 V ~
Rated speed	0-450 rpm
No-load speed	0-650 rpm
Max. drilling-Ø wood/alu/steel	65/28/20 mm*
Reversible	yes
Spindle connection	5/8" x 16 UN
Collar diameter	43 mm
Weight	3.2 kg
Order no.	0121E000

Supplied in a box
incl. drill chuck key

* Drill with shaft 16 mm

SPECIFICATIONS	EHB 16/2.4 S R/L
Power input	1150 W
Rated voltage	230 V ~
Rated speed	0-430/0-760 rpm
No-load speed	0-700/0-1200 rpm
Max. drilling-Ø wood/alu/steel	65/28/20 mm*
Reversible	yes
Spindle connection	5/8" x 16 UN
Collar diameter	43 mm
Weight	3.5 kg
Order no.	0122H000

Supplied in a box
incl. drill chuck key



Hand-held drilling machine EHB 20/2.4



Ø 20
in steel

MT 2

Magnetic drill rig B 32.1



Max. drilling diameter:
twist drill 32 mm
core drill 100 mm
taper M 20

High torque model

APPLICATION:

- Drilling of wood, aluminium, steel
- Metal and timber construction

FEATURES:

- 2-speed gearbox – ideal transmission for high torques
- Morse taper connection – versatile spindle connection

Strong magnetic connection for safe working

APPLICATION:

- Safety drilling and milling overhead and on sloping steel surfaces
- Metal and timber construction, machine, plant and vehicle construction

FEATURES:

- Connecting screw drill stand/drilling machine for precise guiding especially for core hole drilling – protection against turning
- Base with high magnetic force – safe working
- Robust design with solid, durable dovetail guide
- Suitable for the EIBENSTOCK EHB 32/2.2 R/L and EHB 32/4.2 models

SPECIFICATIONS	EHB 20/2.4
Power input	1150 W
Rated voltage	230 V ~
Rated speed	250/450 rpm
No-load speed	400/730 rpm
Max. drilling-Ø wood/alu/steel	70/40/20 mm
Reversible	no
Spindle connection	MT 2
Collar diameter	46 mm
Weight	4.2 kg
Order no.	0132A000
Supplied	in a box incl. drill drift MT 2

SPECIFICATIONS	B 32.1
Power input	110 W
Rated voltage	230 V ~
Magnetic holding force	16000 N
Size of magnet	220 x 110 mm
Collar diameter	65 mm
Hub	180 mm
Height	409 mm
Socket outlet	max. 16 A
Weight	17.0 kg
Order no.	09507000
Supplied	in a case incl. safety belt, weldon mounting shank MT 3 and assembly tools





Hand-held drilling machine EHB 32/2.2 R R/L

Reversible



Ø 32
in steel

2

Hand-held drilling machine EHB 32/4.2



Ø 32
in steel

4

Powerful models

APPLICATION:

- Hand-held or stand mounted drilling in wood, aluminium, steel
- Screwing and tapping (EHB 32/2.2 R R/L forward reverse and torque control)
- As a driving motor
- Metal and timber construction, machine, plant and vehicle construction

FEATURES:

- Soft start, temperature control and over current cut-off (EHB 32/2.2 R R/L) – protection of the machine
- Torque control, speed regulation and constant speed (EHB 32/2.2 R R/L) – optimal adjustment to material and drilling diameter
- Mechanical safety clutch – protection of the user
- Morse taper connection – versatile spindle connection



SPECIFICATIONS	EHB 32/2.2 R R/L
Power input	1800 W
Rated voltage	230 V ~
Rated- /No-load speed	60-140/200-470 rpm
Max. drilling-Ø wood/alu/steel	100/60/32 mm
Reversible	yes
Spindle connection	MT 3
Collar diameter	65 mm
Weight	6.4 kg
Order no.	0152H000
Supplied	in a box incl. drill drift MT 3

SPECIFICATIONS	EHB 32/4.2
Power input	1700 W
Rated voltage	230 V ~
Rated speed	110/175/245/385 rpm
No-load speed	215/330/460/680 rpm
Max. drilling-Ø wood/alu/steel	100/60/32 mm
Reversible	no
Spindle connection	MT 3
Collar diameter	65 mm
Weight	6.9 kg
Order no.	0154A000
Supplied	in a box incl. drill drift MT 3



Dry-wall screwdriver **ESR 450**

The compact and powerful entry level

APPLICATION:

- Fixing of construction boards (e.g. plasterboards) on metal and wood frames as well other assembly work

FEATURES:

- Powerful motor – clean and quick countersink of screws up to \varnothing 5 mm
- Speed control, acceleration function, reversible
- Electronic switch with lock for continuous use
- Gearbox with internal gear teeth – durable
- Detachable depth gauge with notch stops
- Automatic switch off when reaching the screw depth
- Soft handle, belt clip



belt clip



detachable depth gauge with notch stops

Ø5
 in Wood

SPECIFICATIONS

ESR 450

Power input	450 W
Rated voltage	230 V ~
No-load speed	0-4000 rpm
Screws in wood	\varnothing 5 mm
Corner accessibility	33.0 mm
Collar diameter	-
Spindle connection	1/4"
Weight	1.2 kg

Order no. 06102000









Supplied in a box incl. depth gauge





Drilling ACCESSORIES

FOR HAND-HELD DRILLING MACHINES

	<p>1 Magnetic drill rig B 32.1 for EHB 32/2.2 R R/L and EHB 32/4.2</p>	<p>09507000</p>
	<p>2 Weldon mounting shank MK 3 - Ø 19 mm</p>	<p>33125000</p>
	<p>3 Taper mandrel B 16/MT 2 B 18/MT 2 B 18/MT 3</p>	<p>33111000 33112000 33122000</p>
	<p>4 Quick action drill chuck ½" x 20 Ø 13 mm B 16 Ø 13 mm B 16 Ø 16 mm ⅝" x 16 UN Ø 16 mm</p>	<p>33433000 33431000 33441000 33444000</p>
	<p>5 Scroll chuck B 18 Ø 16 mm</p>	<p>33342000</p>
	<p>6 Adapter MT 2 male - M 14 female MT 3 male - M 14 female</p>	<p>33113000 33123000</p>
	<p>7 Drill chuck key 16</p>	<p>33540000</p>
	<p>8 Plastic case for EHB 16, EHB 20/2.4</p>	<p>37332000</p>

DIAMOND CORE DRILLING





Model	Page	Dry/wet drilling	Spindle connection	Power input	Rated speed (*No-load speed)	
DRY CORE DRILLING						
EHD 1500 03E11000		22	 32-82 mm	M 18 male	1500 W	0-2000 rpm
EHD 2000 S 0332L000		24	 32-132 mm	M 18 male	1700 W	0-1000/ 0-2000 rpm
EHD 1801 0331U000		26	 max. 250 mm	M 18 male	1800 W	0-550 rpm
ESD 1801 03217000		28	 max. 90 mm	M 18 male	1800 W	0-2050 rpm
WET-DRY CORE DRILLING						
ETN 162/3 03E31000		30	 12-202 mm  12-162 mm	G½" female + 1¼" male	2200 W	0-510/ 0-1150/ 0-2500 rpm
PowerLine PLD 182.1 NT 0343X000 NEW		32	 12-202 mm  12-182 mm	G½" female + 1¼" male	2300 W	0-520/ 0-1200/ 0-2500 rpm
WET CORE DRILLING						
END 712 P 03015000		34	 up to 18 mm	M 12 x 1.5 male	700 W	0-8000 rpm
END 1550 P 03114000		36	 6-68 mm	G½" female	1500 W	1800- 4400 rpm

Hazardous dust (e. g. silica dust) has to be suctioned by a Dust Class M Vacuum Cleaner!
For our electric power tools we are recommending to use a Vacuum Cleaner of our Eibenstock DSS range!

Model		Page	Dry/wet drilling	Spindle connection	Power input	Rated speed (*No-load speed)
CORE DRILLING UNITS						
DBE 162 03E35000		46	 12-202 mm  12-162 mm	G½" female + 1¼" male	2200 W	0-510/ 0-1150/ 0-2500 rpm
PowerLine PLE 182 0343S000		47	 12-202 mm  12-182 mm	G½" female + 1¼" male	2300 W	0-520/ 0-1200/ 0-2500 rpm
DB 201 0B33R000		48	 202 mm	G½" female + 1¼" male	2500 W	*675 rpm
DBE 182 03E34000		49	 12-202 mm	G½" female + 1¼" male	2300 W	480/ 1080/ 2350 rpm
DBE 250 R 0352I000		50	 52-252 mm	1¼" male	2500 W	360/ 850 rpm
DBE 352 03642000		51	 42-352 mm	1¼" male	3000 W	230/ 500/ 1030 rpm
PowerLine PLE 450 B 0373B000		52	 72-452 mm	1¼" male	3300 W	180/ 400/ 780 rpm
EFB 68 0662H000		56	 20-68 mm	M 14 male	1400 W	*3000- 10000 rpm
EFB 152 PX 0662B000		58	 6-120 mm	G½" female	1150 W	250-1000 rpm

DIAMOND CORE DRILLING



CHARACTERISTICS OF DIAMOND CORE DRILLS

With a wide range of different diamond core drills EIBENSTOCK offers tailored solutions for diamond core drilling between diameter 3.5 and 450 mm. The comprehensive machine, drill and accessory program is not only convincing plumbers and electricians but also other craftsman all around the construction.

The **PowerLine**-Series is a specially designed machine concept for series drilling and continuous use in the construction and civil engineering.





SPECIFICATIONS	EHD 1500/EHD 1500 SET
Power input	1500 W
Rated voltage	230 V ~
Rated speed	0-2000 rpm
No-load speed	0-3700 rpm
Drilling diameter	32-82 mm
Spindle connection	M 18 male
Collar diameter	46 mm
Weight	3.9 kg
Order no.	03E11000/03E13000
Supplied EHD 1500	in a case without accessories
Supplied EHD 1500 Set	in a case incl. dust extraction HB, drill bit for socket outlets Ø 82 mm and centering drill

Diamond dry core drill EHD 1500

The handy machine – ideal for socket sinking in the installation business up to Ø 82 mm

APPLICATION:

- Dry drilling up to Ø 82 mm in sand-lime brick, brickwork, clinker, brick and other abrasive materials
- For electrical installation work – socket sinking, e.g. switches and sockets

FEATURES:

- Electronic – soft start, temperature control and over current cut-off, overload indication
- Mechanical safety clutch
- Low weight with high power
- PUR-construction site cable – strong for heavy duty use
- Ergonomic handle and large-dimensional switch button – good control and effortless working



overload indication



EHD 1500 Set





Diamond dry core drill EHD 1500 – ACCESSORIES

WITHOUT DUST EXTRACTION

Material



for brickwork, soft concrete

Centering shaft
spring loaded



35612000

Drill bit for socket outlets dry M 16



A Ø 68 mm and Ø 82 mm

Adapter H

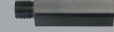

M 16 m - M 18 f

35512000

Adapter SDS



M 16 m - M 18 f incl. SDS drill bit

35514000

M 18 m



DIAMOND CORE DRILLING

WITH DUST EXTRACTION HB

Material



for brickwork, soft concrete

Centering drill



35614000

Drill bit for socket outlets dry M 16



B Ø 68 mm and Ø 82 mm

Dust
extraction HB



M 16 m - M 18 f

35242000



for sand-lime brick



35614000



C Ø 68 mm and Ø 82 mm

A B C Diamond drill bits see page 53

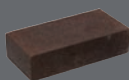

Sharpening block
200 x 100 x 50 mm

35910000



Centering shaft, spring loaded
for dust extraction H 35240000

35612000



Hazardous dust (e. g. silica dust)
has to be suctioned by a Dust
Class M Vacuum Cleaner!
For our electric power tools
we are recommending to
use a Vacuum Cleaner of our
Eibenstock DSS range!



▶▶ Diamond dry core drill EHD 2000 S

The universal tool for installation holes up to Ø 132 mm

APPLICATION:

- Dry drilling up to Ø 132 mm in sand-lime brick, brickwork, clinker, brick and other abrasive materials
- Producing of wall and roof openings for sanitary, heating and ventilation installations
- For electrical installation work – socket sinking, e.g. switches and sockets

FEATURES:

- Electronic – soft start, temperature control and over current cut-off
- Robust 2-speed gearbox
- Mechanical safety clutch
- Additional handle – variable adjustment on the collar



SPECIFICATIONS	EHD 2000 S
Power input	1700 W
Rated voltage	230 V~
Rated speed	0-1000/0-2000 rpm
No-load speed	0-1500/0-3000 rpm
Drilling diameter	32-132 mm
Spindle connection	M 18 male
Collar diameter	53 mm
Weight	5.5 kg
Order no.	0332L000
Supplied	in a case without accessories



A Diamond dry core drill EHD 2000 S – ACCESSORIES

WITHOUT DUST EXTRACTION

Material



for brickwork, soft concrete

Centering shaft
spring loaded



35612000

Drill bit for socket outlets dry M 16



A Ø 68 mm and Ø 82 mm

Adapter H



M 16 m - M 18 f

35512000

Adapter SDS

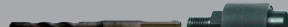

M 16 m - M 18 f incl. SDS drill bit

35514000

M 18 m



DIAMOND CORE DRILLING

WITH DUST EXTRACTION HB

Material



for brickwork, soft concrete

Centering drill



35614000

Drill bit for socket outlets dry M 16



B Ø 68 mm and Ø 82 mm

Dust
extraction HB



M 16 m - M 18 f

35242000

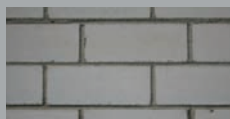

for sand-lime brick



35614000



C Ø 68 mm and Ø 82 mm



for hard sand-lime brick

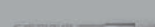

35614000



C

NEW

WITH DUST EXTRACTION M 18 - 1¼"

Material



for brickwork,
sand-lime brick

Centering rod

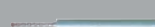

200 mm 36395000

450 mm 36391000

Diamond dry drill bits 1¼"



D 200 mm, Ø 82-132 mm

E 420 mm, Ø 52-132 mm

Dust
extraction



1¼" m - M 18 f

35230000

A B C D E Diamond drill bits see page 53



Sharpening block
200 x 100 x 50 mm

35910000



Copper ring 1¼"
for easy removal of the drill bit

35450000 1 piece



Slider quick release ring 1¼"
for drill bits

35652000 1 piece



Hazardous dust (e. g. silica dust)
has to be suctioned by a Dust
Class M Vacuum Cleaner!
For our electric power tools
we are recommending to
use a Vacuum Cleaner of our
Eibenstock DSS range!

Centering shaft, spring loaded
for dust extraction H 35240000

35612000



Diamond dry core drill EHD 1801

Hand-held dry core drilling up to Ø 250 mm

APPLICATION:

- Drills up to Ø 250 mm in sand-lime brick, brickwork, clinker, brick and other abrasive materials as well ceramics
- Connecting holes for chimney and heating installations
- Producing of wall and roof openings for sanitary, heating and ventilation installations

FEATURES:

- Powerful motor
- Electronic – soft start, temperature control and over current cut-off
- Oil bath gearbox – optimal lubrication
- Metal gearbox housing – robust, durable
- Mechanical safety clutch
- Additional handle – variable adjustment on the collar
- Compact design – handy and balanced



SPECIFICATIONS	EHD 1801
Power input	1800 W
Rated voltage	230 V ~
Rated speed	0-550 rpm
No-load speed	0-800 rpm
Drilling diameter	132-250 mm
Spindle connection	M 18 male
Collar diameter	53 mm
Weight	5.4 kg
Order no.	0331U000
Supplied	in a case without accessories



- Can be used with the chimney drill rig KBS 250 (accessory)





Diamond dry core drill EHD 1801 – ACCESSORIES

WITH DUST EXTRACTION M 18 - 1¼"

Material



for brickwork,
sand-lime brick



for ceramic pipes,
e.g. for chimneys

Centering rod

200 mm **36395000**
450 mm **36391000**

Diamond dry drill bits 1¼"

D 200 mm, Ø 132-250 mm
E 420 mm, Ø 132-202 mm

Ceramic drill bit 1¼"

F 150 mm, Ø 182 mm

Dust extraction

1¼" m - M 18 f
35230000

M 18 m



Hazardous dust (e. g. silica dust)
has to be suctioned by a Dust
Class M Vacuum Cleaner!
For our electric power tools
we are recommending to
use a Vacuum Cleaner of our
Eibenstock DSS range!

DIAMOND CORE DRILLING

D E F Diamond drill bits see page 53



Sharpening block
200 x 100 x 50 mm
35910000

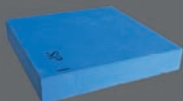

Sharpening plate
320 x 320 x 55 mm
35913000



Copper ring 1¼"
for easy removal of the drill bit
35450000 1 piece



Slider quick release ring 1¼"
for drill bits
35652000 1 piece



Chimney drill rig
KBS 250 (see page 44)
09648000



SPECIFICATIONS	ESD 1801
Power input	1800 W
Rated voltage	230 V ~
Rated speed	0-2050 rpm
No-load speed	0-3000 rpm
Blows	41000 bpm
Drilling diameter	68-92 mm
Spindle connection	M 18 male
Collar diameter	53 mm
Weight	5.9 kg
Order no.	03217000
Supplied	in a case without accessories

Diamond dry soft percussion core drill ESD 1801

With soft percussion for hard materials up to Ø 92 mm

APPLICATION:

- Dry drilling up to Ø 92 mm for particularly hard materials, e.g. highly compressed limestone, reinforced concrete and other abrasive materials with a high working speed
- Producing of wall and roof openings for sanitary, heating and ventilation installations
- For electrical installation work – socket sinking, e.g. switches and sockets

FEATURES:

- Powerful motor
- Electronic – soft start
- Gearbox with switchable soft percussion – high working speed
- Mechanical safety clutch
- Additional handle – variable adjustment on the collar



adjustment ring for soft percussion



A Diamond dry soft percussion core drill ESD 1801 – ACCESSORIES

WITHOUT DUST EXTRACTION

Material



for brickwork, soft concrete

Centering shaft
spring loaded



35612000

Drill bit for socket outlets dry M 16



A Ø 68 mm and Ø 82 mm

Adapter H

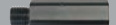

M 16 m - M 18 f

35512000

Adapter SDS



M 16 m - M 18 f incl. SDS drill bit

35514000

M 18 m



DIAMOND CORE DRILLING

WITH DUST EXTRACTION HB

Material



for brickwork, soft concrete

Centering drill



35614000

Drill bit for socket outlets dry M 16



B Ø 68 mm and Ø 82 mm



for sand-lime brick



35614000



C Ø 68 mm and Ø 82 mm



for reinforced concrete,
sand-lime brick



35615000

Diamond dry drill
bits M 16

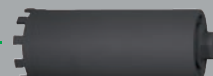

G 150 mm
Ø 52-82 mm

Spacer



35241000
for Ø 52 mm

Dust
extraction HB



M 16 m - M 18 f

35242000

WITH DUST EXTRACTION M 18 - 1¼"

Material

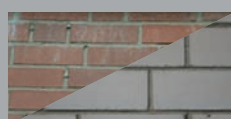

for brickwork,
sand-lime brick

Centering rod

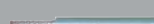

200 mm 36395000

450 mm 36391000

Diamond dry drill bits 1¼"



D 200 mm, Ø 82 mm

E 420 mm, Ø 52-82 mm

Dust
extraction



1¼" m - M 18 f

35230000

A B C D E G Diamond drill bits see page 53



Sharpening block
200 x 100 x 50 mm

35910000



Copper ring 1¼"
for easy removal of the drill bit

35450000 1 piece



Slider quick release ring 1¼"
for drill bits

35652000 1 piece



Hazardous dust (e. g. silica dust)
has to be suctioned by a Dust
Class M Vacuum Cleaner!
For our electric power tools
we are recommending to
use a Vacuum Cleaner of our
Eibenstock DSS range!

Centering shaft, spring loaded
for dust extraction H 35240000

35612000

35613000

70 mm

150 mm



SPECIFICATIONS		ETN 162/3	
Power input		2200 W	
Rated voltage		230 V ~	
Rated- /No-load speed		0-510/-1.150/-2.500 rpm	
C (w Drilling diameter	oncrete et)	1. Gear	82-162 mm
		2. Gear	42-82 mm
		3. Gear	12-42 mm
Br (dr	ickwork y)	1. Gear	122-202 mm
		2. Gear	62-122 mm
		3. Gear	12-62 mm
Spindle connection		G½" female + 1¼" male	
Collar diameter		60 mm	
Weight		6.7 kg	
Order no.		03E31000	
Supplied		in a case incl. water supply and dust extraction, jaw wrench SW 32 + 41	

Diamond wet-dry core drill ETN 162/3

The versatile drill for drilling up to Ø 162 mm in concrete

APPLICATION:

- Dry drilling in sand-lime brick, brickwork, clinker, brick and other abrasive materials as well as wet drilling in reinforced concrete, natural stone and asphalt
- Sanitary, heating and ventilation construction, civil engineering, landscape construction

FEATURES:

- Powerful 2200 W motor with high power reserves and a long lifetime
- Electronic – soft start, temperature control and over current cut-off, overload indication, constant speed
- Cut-off carbon brushes
- Service indicator – lights up approx. 10 working hours before the cut off carbon brushes need to be replaced
- 3-speed oil bath gearbox – for optimal lubrication in all working positions and optimal adjusted torque-speed-ratio for all diameters
- Mechanical safety clutch
- Combination spindle with integrated connection for centering rod – fast, precise spot drilling
- Ergonomic handle with large-dimensioned switch button – good control and effortless working
- PUR-construction site cable – strong for heavy duty use
- Adapter change – fast conversion between wet and dry applications
- Integrated levels on machine and handle
- Quick-mounting system – fixing of the machine including handle into the rig without any tools



A Diamond wet-dry core drill ETN 162/3 – ACCESSORIES

FOR WET DRILLING

Material



for reinforced concrete



for reinforced concrete

Diamond wet drill bits R½"

- H** 300 mm, Ø 12-31 mm
- I** 420 mm, Ø 38-51 mm

Diamond wet drill bits 1¼"

- J** 450 mm, Ø 41-161 mm

(from Ø 80 mm drill rig required)

 Centering device with water collection
max. Ø 82 mm

FOR DRY DRILLING WITH DUST EXTRACTION

Material

 for brickwork,
sand-lime brick

Centering rod

- 200 mm **36395000**
- 450 mm **36391000**

Diamond dry drill bits 1¼"

- D** 200 mm, Ø 82-202 mm
- E** 420 mm, Ø 52-202 mm

Hazardous dust (e. g. silica dust)
has to be suctioned by a Dust
Class M Vacuum Cleaner!
For our electric power tools
we are recommending to
use a Vacuum Cleaner of our
Eibenstock DSS range!



Water tank
10 l metal, incl. 3.5 m hose
with Gardena-Connector

35812000
D E H I J

Diamond drill bits see page 53

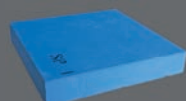

Sharpening block
200 x 100 x 50 mm

35910000

Sharpening plate
320 x 320 x 55 mm

35913000

Copper ring 1¼"
for easy removal of the drill bit

35450000 1 piece

Slider quick release ring 1¼"
for drill bits

35652000 1 piece

Guide ring for centering device
Please name order no. + Ø!

+ 25, 38, 41, 51, 61, 68, 82 mm



Drill rig
BST 182 V/S (see page 44)

09646000

Diamond core drilling unit
DBE 162 (see page 46)

03E35000



PowerLine



**Optimized efficiency with special gearbox
adjustment for powerful drilling progress
Robust full-aluminium-housing**



SPECIFICATIONS

PLD 182.1 NT

Power input		2300 W
Rated voltage		230 V ~
Rated speed		0-520/-1200-2500 rpm
No-load speed		0-1000/0-2200/0-4400 rpm
C (w Drilling diameter	oncrete et)	1. Gear 82-182 mm
		2. Gear 42-82 mm
		3. Gear 12-42 mm
Br (dr	ickwork y)	1. Gear 122-202 mm
		2. Gear 62-122 mm
		3. Gear 12-62 mm
Spindle connection		G½" female + 1¼" male
Collar diameter		60 mm
Weight		7.5 kg
Order no.		0343X000

Supplied PLD 182.1 NT in a case, connection for dust extraction and water supply, jaw wrench SW 32/41

» Diamond wet-dry core drill PLD 182.1 NT

The machine for hardest applications in series drilling up to Ø 182 mm in concrete

APPLICATION:

- Dry drilling in sand-lime brick, brickwork, clinker, brick and other abrasive materials as well as wet drilling in reinforced concrete, natural stone and asphalt
- Drilling operators, civil engineering, sanitary, heating and ventilation construction, other installation companies, gardening and landscaping

FEATURES:

- Powerful 2300 W motor with high power reserves and a long lifetime, able for continuous work under pressure
- Electronic – soft start, over current cut-off, overload indication, cut off carbon brushes
- 3-speed oil bath gearbox – for optimal lubrication in all working positions and optimal adjusted torque-speed-ratio for all diameters
- Mechanical safety clutch
- Combination spindle with integrated connection for centering rod – fast, precise spot drilling
- Ergonomic handle with large-dimensioned switch button – good control and effortless working
- Cut-off carbon brushes
- PUR-construction site cable – strong for heavy duty use
- Integrated levels on machine



Shortest design in its power range – ideal for narrow spaces

A Diamond wet-dry core drill PLD 182.1 NT – ACCESSORIES

PowerLine

FOR WET DRILLING

Material



for reinforced concrete

Diamond wet drill bits R½"

- H** 300 mm, Ø 12-31 mm
- I** 420 mm, Ø 38-51 mm



for reinforced concrete

Diamond wet drill bits 1¼"

- J** 450 mm, Ø 41-181 mm

(from Ø 80 mm drill rig required)



FOR DRY DRILLING WITH DUST EXTRACTION

Material

 for brickwork,
sand-lime brick

Centering rod

- 200 mm **36395000**
- 450 mm **36391000**

Diamond dry drill bits 1¼"

- D** 200 mm, Ø 82-202 mm
- E** 420 mm, Ø 52-202 mm

Hazardous dust (e. g. silica dust) has to be suctioned by a Dust Class M Vacuum Cleaner! For our electric power tools we are recommending to use a Vacuum Cleaner of our Eibenstock DSS range!



Water tank
10 l metal, incl. 3.5 m hose with Gardena-Connector

35812000
D E H I J

Diamond drill bits see page 53

Sharpening block
200 x 100 x 50 mm

35910000

Sharpening plate
320 x 320 x 55 mm

35913000

Copper ring 1¼"
for easy removal of the drill bit

35450000 1 piece

Slider quick release ring 1¼"
for drill bits

35652000 1 piece

Drill rig
BST 182 V/S (see page 44)

09646000

Connecting adapter
universal tool holder/
collar Ø 60 mm

35829000

Diamond core drilling unit
PLE 182 (see page 47)

03435000



SPECIFICATIONS	END 712 P	
Power input	700 W	
Rated voltage	230 V ~	
Rated speed	0-8000 rpm	
No-load speed	0-11000 rpm	
Max. drilling diameter	full drill bits	12 mm
	hollow drill bits	18 mm
Spindle connection	M 12 x 1.5 male	
Collar diameter	43 mm	
Weight	2.6 kg	
Order no.	03015000	
Supplied	in a case incl. depth gauge, jaw wrench SW 13/17	

Diamond wet drill END 712 P

The fast model for up to Ø 18 mm

APPLICATION:

- Wet drilling in natural stone, tiles, ceramics, porcelain, stoneware, glass, concrete
- Blind or through holes for fitting connectors as well as gravestones and countertops
- Dowel holes
- Tilers, stonemasons and installation companies

FEATURES:

- Electronic switch – stepless speed control
- Optimal concentricity
- Stainless steel spindle
- Integrated water supply
- Easy to service – shaft seals are easily replaceable
- Water supply control – stepless quantity control
- Low weight, ergonomic design – easy handling
- Centering device (accessory)



3583E000

starter kit: centering device with drilling template, water suction hose with Gardena-Connector, diamond wet full drill bits 6/8 mm, sharpening block



A Diamond wet drill END 712 P – ACCESSORIES

FOR WET DRILLING

Material



for concrete, tiles

Centering device with
drilling template

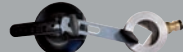

3583A000

Diamond wet full drill bits



K 150 mm, Ø 6-12 mm

Centering device with
drilling template



3583A000

Diamond wet full drill bits



L 60 mm, Ø 6-12 mm



for concrete, tiles

Centering device with
drilling template



3583A000

Diamond wet hollow drill bits



M 60 mm, Ø 6-18 mm



for natural stone, tiles



Water tank

5 l plastic, incl. 4.0 m hose
with Gardena-Connector

35811000

10 l metal, incl. 3.5 m hose
with Gardena-Connector

35812000

K L M Diamond drill bits see page 53



Sharpening block
200 x 100 x 50 mm

35910000



» Diamond wet core drill END 1550 P

The versatile model for up to Ø 68 mm holes

APPLICATION:

- Wet drilling in natural stone, tiles, ceramic, porcelain, stoneware, glass, reinforced concrete
- Blind or through holes for fitting connectors as well as gravestones and worktops
- Anchor holes
- Mounting holes for switches
- Tilers, stonemasons and installation companies

FEATURES:

- Electronic – soft start, speed regulation and constant speed, temperature control and over current cut-off
- Stainless steel spindle
- Integrated water supply
- Water supply control – stepless quantity control
- Quick-change system
- Can be used with drill rig to keep stationary
- Centering device (accessory)



SPECIFICATIONS	END 1550 P
Power input	1500 W
Rated voltage	230 V ~
Rated- /No-load speed	1800-4400 rpm
Drilling diameter	6-68 mm
Spindle connection	G½" female
Collar diameter	53 mm
Weight	3.6 kg
Order no.	03114000
Supplied	in a case incl. quick changing adapter and adapter M 12 x 1.5 m - G½"



speed regulation



water supply control



A Diamond wet core drill END 1550 P – ACCESSORIES

FOR WET DRILLING

Material

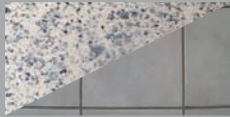

for natural stone, tiles



for natural stone



for reinforced concrete



for concrete



for natural stone, tiles

Diamond wet drill bits R $\frac{1}{2}$ "



N 40 mm, Ø 22-68 mm



O 150 mm, Ø 18-51 mm



H 300 mm, Ø 10-31 mm

Diamond wet full drill bits



L 60 mm, Ø 6-12 mm

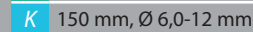

K 150 mm, Ø 6,0-12 mm

Diamond wet hollow drill bits

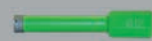

M 60 mm, Ø 6-18 mm

Spare seals for centering device

35842000

Quick change adapter

G $\frac{1}{2}$ " - G $\frac{1}{2}$ "

38004000

Quick change top

38006000

Adapter

M 12 x 1.5 m - G $\frac{1}{2}$ "

35122000

Centering device with water collection (Gardena-Connector) max. Ø 30 mm

35836000

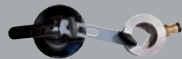
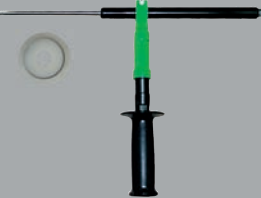

Centering device with drilling template

3583A000



Water tank

5 l plastic, incl. 4.0 m hose
with Gardena-Connector

35811000

10 l metal, incl. 3.5 m hose
with Gardena-Connector

35812000

H K L M N O Diamond drill bits see page 53



Sharpening block
200 x 100 x 50 mm

35910000



3 Spare seals
for quick change adapter

35125000



Guide ring for centering device
Please name order no. + Ø!

358400 ... + 06, 08, 10, 12, 13, 14, 15, 16, 18, 20, 21, 22, 24, 25, 28, 30 mm



Drill rig BST 90

09629000

Drill rig BST 50 V

09645000

see page 44



DIAMOND CORE DRILLING



FEATURES OF CORE DRILL MOTORS

Our core drills have a solid and sturdy construction and can be mounted to a variety of drill rigs.

The **PowerLine**-Series is a specially designed machine concept for series drilling and continuous use in the construction and civil engineering.

THE POWERFUL MOTORS



Model	EBM 182/3	EBM 250/2 RP	EBM 352/3	PowerLine PLD 450.1 B
Power input	2300 W	2500 W	3000 W	3300 W
Rated speed	480/1080/2350 rpm	360/850 rpm	230/500/1030 rpm	180/400/780 rpm
No-load speed	480/1080/2350 rpm	360/850 rpm	230/500/1030 rpm	300/650/1300 rpm
Constant speed	x	x	x	–
Full aluminium housing	–	–	–	x
Drilling diameter	12-202 mm	51-252 mm	41-352 mm	71-452 mm
Spindle connection	G½" female-1¼" male	1¼" male	1¼" male	1¼" male
Machine connection	Quick-mounting system	Universal tool holder	Universal tool holder	Universal tool holder
Weight	6.7 kg	10.5 kg	12.5 kg	15.3 kg
Order no.	03E33000	0352H000	03641000	0373C000
Supplied	in a box incl. jaw wrench SW 32/41	in a box incl. jaw wrench SW 32/41	in a box incl. jaw wrench SW 32/41	in a box incl. jaw wrench SW 32/41



Patented system



**Reducing ring
(see accessories
page 55)**

 Ø 60 - Ø 53 mm
 Ø 60 - Ø 43 mm

If required, also order!

SPECIFICATIONS	EBW 2300
Working height	1460-2300 mm
Collar diameter	max. 60 mm
Weight	39.0 kg
Order no.	09654000
Supplied	in a box
Accessories	Machine arm
Working height	300-1460 mm
Order no.	3582E000



Drill rig "Bohrwurm" EBW 2300

Body-protecting drilling with low risk potential

APPLICATION:

- For EIBENSTOCK diamond core drills as well as core drills and hammer drills from various manufacturers with 60 mm collar diameter
- The mobile drill rig for drilling up to 2.30 m working height
- Sanitary, heating and ventilation construction, other installation companies, civil engineering, drilling operators

FEATURES:

- Fatigue-free and relaxed drilling
- Reduces the risk of accidents to a minimum – no injuries of the wrists in the case of blocking
- Hydraulic height adjustment enables a safe lowering of the machine incl. drill bit and drill core
- The max. drilling height may not exceed 2.30 m
- No installation damages on the wall like during the use of „conventional“ drill rigs
- Short set-up times, also for high drillings
- High efficiency for series drillings at the same height
- Easy and space saving transport



THE FEATURES OF THE DRILL RIG "BOHRWURM" EBW 2300



Easy assembly

single components can be put together without any tools

Valve

hydraulic enables a safe lowering of the machine incl. drill bit and drill core

Hydraulic foot-operated pump

easy height adjustment

Smooth-running wheels

mobility at the job-site

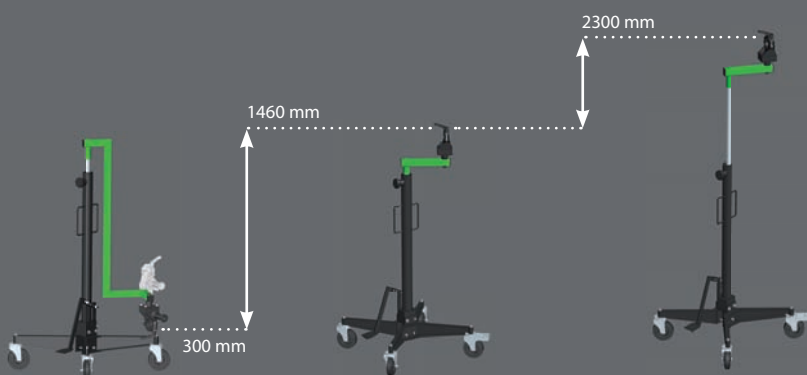
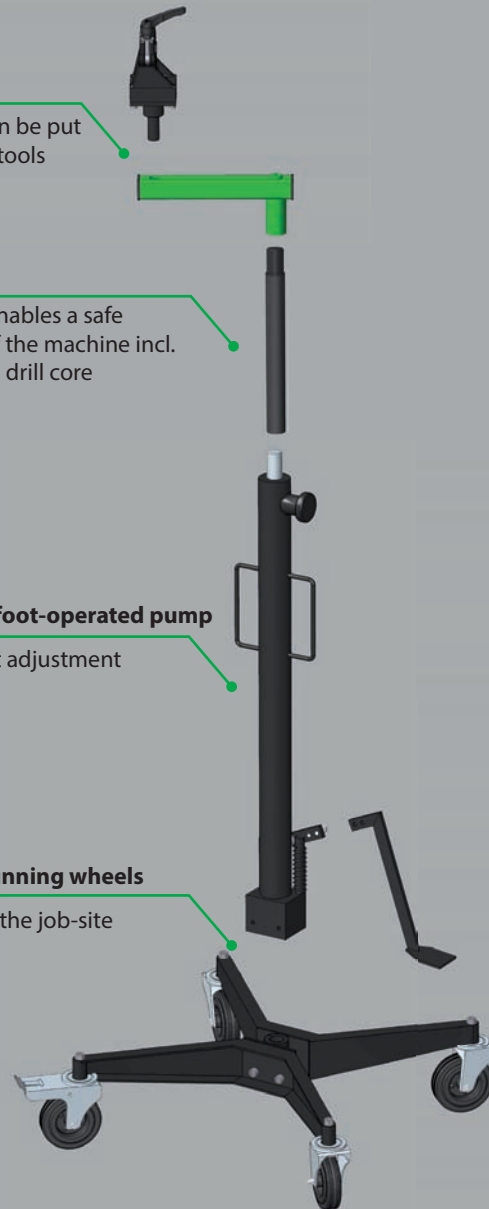

Accessory:

Machine arm
Working height 300-1460 mm



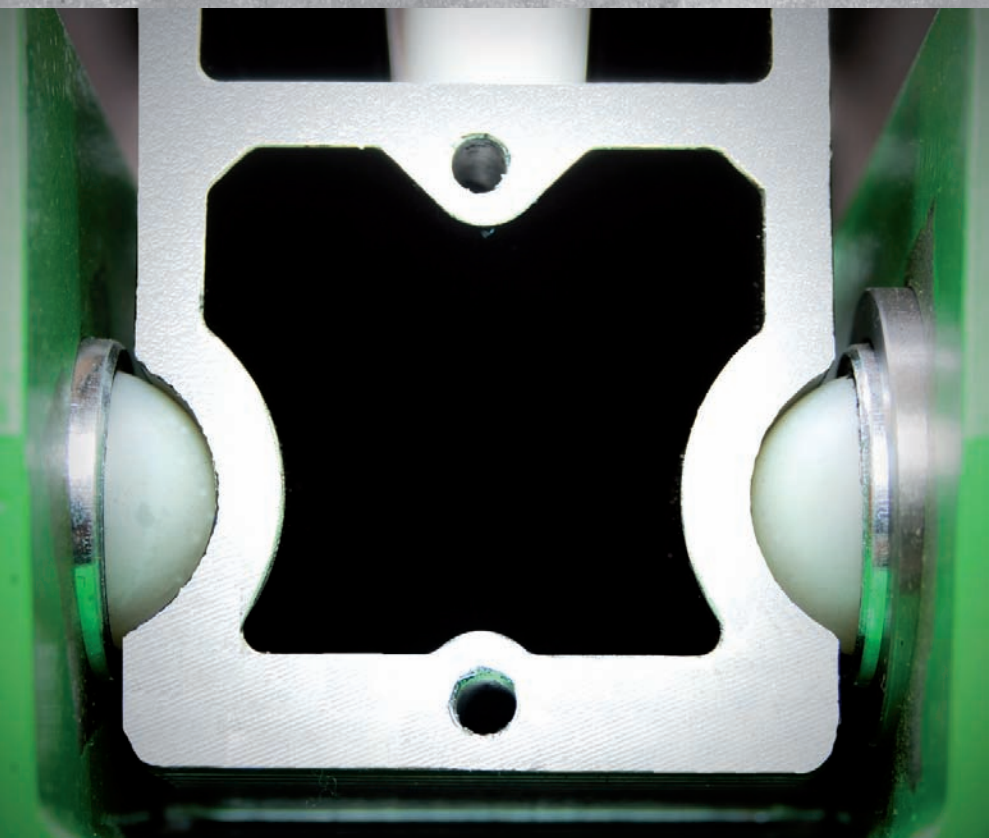



Machine connection

can be used with drill motors of various brands

- Quick-mounting system
- Universal tool holder
- Collar mounting



Scale

easy adjustment of drilling depth

Toothing

wide and constant, precise, long-lived

Aluminium colum*

high torsional strength, light, 45° swivel

Adjusting screws

robust, exact adjustment

Hole centre indicator*

exact positioning

Guides/bearings

smooth running, hard-wearing, adjustable

Spirit level

easy to level (horizontal/vertical)

Feed lever

change without any tool, easy selection of the operating side

Additional handle*

easy transport

Rollers*

quick to mount, easy and light transport

* not present on all models

Base

- Space saving base (anchor)
- Combined base (anchor or vacuum)
- Special mounting (manual with two suckers)

FEATURES OF DRILL RIGS







Our assortment of drill rigs and accessories that were developed and produced in EIBENSTOCK can be used for a variety of tasks, including drilling holes up to \varnothing 450 mm. The drill rigs are very light and easy to handle and can be used by a wide spectrum of the construction industry; from civil engineering and installation companies through to bricklayers and tilers.

The **PowerLine**-Series is a specially designed machine concept for series drilling and continuous use in the construction and civil engineering.



DRILL RIGS





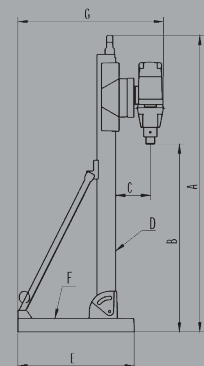

Model	BST 50 V*	BST 90	KBS 250	BST 182 V/S*
Max. drilling-Ø at 90°	68 mm	102 mm 42 mm (vacuum)	250 mm (brickwork)	202 mm
Column length* ¹ / Material	290 mm/ Aluminium	680 mm/ Aluminium	850 mm/ Aluminium	995 mm/ Aluminium
Guides/ Bearings	quadruple on sliding pieces	quadruple on sliding pieces	quadruple on sliding pieces	quadruple on special balls
Quick-mounting system	–	–	–	x 
Universal tool holder	–	–	–	–
Collar mounting	Ø 53 mm 	Ø 53 mm 	Ø 53 mm  Ø 60 mm 	Ø 60 mm with connecting adapter* ³ * ⁴ 
Max. inclination	–	adjustable up to 45°	–	adjustable up to 45°
Weight	6.8 kg	7.0 kg	7.8 kg	14.0 kg
Space saving base (anchor)	–	–	222 x 175 mm	–
Combined base* ² (anchor/vacuum)	–	240 x 170 mm	–	330 x 250 mm
Special mounting	2 suction feet (manual)	–	special for chimney and heating construction	–
Order no.	09645000	09629000	09648000	09646000
Supplied	in a box incl. assembly tools	in a box incl. assembly tools	in a box incl. assembly tools	in a box incl. assembly tools

* with braces *¹ other lengths on request *² Vacuum set necessary (accessory) *³ max. drilling-Ø up to 202 mm *⁴ as accessory

Dimensions in mm	DBE 162	PLE 182	DB 201	DBE 182	DBE 250 R	DBE 352	PLE 450 B
A	1050	1050	855	1050	1040	1030	1116
B	700	830	530	700	685	620	600
C	130	120	120	130	195	200	240
D	46 x 60	46 x 60	46 x 60	46 x 60	70 x 70	60 x 75	60 x 60
E	330	330	225	330	430	400	294
F	250	250	170	250	330	310	194
G	510	500	370	510	590	600	570
Power input	2200 W	2300 W	2500 W	2300 W	2500 W	3000 W	3300 W
max. drill. - Ø	162 mm	182 mm	202 mm	202 mm	252 mm	352 mm	452 mm

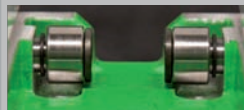



Model	BST 250	BST 352 V*	PowerLine PLB 450*	PowerLine PLB 450 G*
Max. drilling-Ø at 90°	252 mm	352 mm	452 mm	452 mm
Column length*1/ Material	995 mm/ Aluminium	995 mm/ Aluminium	960 mm/ Steel	960 mm/ Aluminium
Guides/ Bearings	quadruple on sliding pieces	quadruple on special balls 	8-fold on steel rolls at the rear 	4-fold on sliding pieces, reinforced at the rear 
Quick-mounting system	–	–	–	–
Universal tool holder	x 	x 	x 	x 
Collar mounting	Ø 60 mm with connecting adapter *3 *4 	Ø 60 mm with connecting adapter *3 *4 	– 	– 
Max. inclination	adjustable up to 45°	adjustable up to 45°	75°/60°/45°	75°/60°/45°
Special features			– torsion-resistant column – rear-mounted carriage – steel toothing, easy to change	– integrated fine feed 1:3 – torsion-resistant column – rear-mounted carriage – steel toothing, easy to change
Weight	15.5 kg	22.5 kg	27.0 kg	26.0 kg
Space saving base (anchor)	430 x 330 mm	–	295 x 195 mm	295 x 195 mm
Combined base*2 (anchor/vacuum)	–	400 x 310 mm	–	–
Special mounting	–	–	–	–
Order no.	09631000	09647000	0962M000	09656000
Supplied	in a box incl. assembly tools	in a box incl. assembly tools	in a box incl. assembly tools	in a box incl. assembly tools

PowerLine PLB 450 G

The drill rig with gearbox with integrated fine feed 1: 3 for better feed control and fatigue-free drilling.



SPECIFICATIONS	DBE 162
Power input	2200 W
Rated voltage	230 V ~
Rated-/No-load speed	0-510/0-1150/0-2500 rpm
Drilling diameter	wet 12-162 mm dry 12-202 mm
Spindle connection	1/2" female + 1/4" male
Column length	995 mm
Hub	700 mm
Weight	20.7 kg
Order no.	03E35000
Supplied	ETN 162/3 + BST 182 V/S without drill bit

Diamond core drilling unit DBE 162

The versatile combination for drilling up to Ø 162 mm

APPLICATION:

- Dry drilling in sand-lime brick, brickwork, clinker, brick and other abrasive materials as well as wet drilling in reinforced concrete, natural stone and asphalt
- Sanitary, heating and ventilation construction, civil engineering, landscape construction

FEATURES:

- Electronic – soft start, temperature control and over current cut-off, overload indication, constant speed
- Service indicator – lights up approx. 10 working hours before the cut off carbon brushes need to be replaced
- 3-speed oil bath gearbox – for optimal lubrication in all working positions due to the specially developed oil pump and optimal adjusted torque-speed-ratio for all diameters
- Mechanical safety clutch
- Combination spindle with integrated connection for centering rod – fast, precise spot drilling
- PUR-construction site cable – strong for heavy duty use
- Changing system – fast conversion between wet and dry applications
- Integrated levels on machine and additional handle as well as on the carriage, scale and hole center indicator on the drill rig – exact drilling
- Quick-mounting system – apply the motor to the drill rig without the need for tools
- Column of the rig can be adjusted to 45°
- Compact combination base – fixing with anchor or vacuum (vacuum set necessary)
- Feed lever change without any tools – easy change of the working site
- Retrofitable wheel axle (accessory) – easy transport



BST 182 V/S:
mounted carriage on 4 special balls



Diamond core drilling unit PLE 182

The powerful combination for hardest applications in series drilling up to Ø 202 mm

APPLICATION:

- Wet drilling in reinforced concrete, natural stone and asphalt
- Drilling operators, civil engineering, sanitary, heating and ventilation construction, other installation companies, gardening and landscaping

FEATURES:

- Electronic – soft start, over current cut-off, overload indication, cut off carbon brushes
- 3-speed oil bath gearbox – for optimal lubrication in all working positions due to the specially developed oil pump and optimal adjusted torque-speed-ratio for all diameters
- Mechanical safety clutch
- Combination spindle with integrated connection for centering rod – fast, precise spot drilling
- PUR-construction site cable – strong for heavy duty use
- Integrated levels on machine and on the carriage, scale and hole center indicator on the drill rig – exact drilling
- Collar mounting – variable machine position in the rig
- Column of the rig can be adjusted to 45°
- Compact combination base – fixing with anchor or vacuum (vacuum set necessary)
- Feed lever change without any tools – easy change of the working site
- Retrofitable wheel axle (accessory) – easy transport

PowerLine

Optimized efficiency
with special gearbox
adjustment for
powerful drilling
progress

Robust full-
aluminium-
housing



DIAMOND CORE DRILLING



SPECIFICATIONS	PLE 182
Power input	2300 W
Rated voltage	230 V ~
Rated speed	0-520/-1.200/-2.500 rpm
No-load speed	0-1000/-2.200/-4.400 rpm
Drilling diameter	wet 12-182 mm dry 12-202 mm
Spindle connection	G½" female + 1¼" male
Column length	995 mm
Hub	700 mm
Weight	21.5 kg
Order no.	0343S000
Supplied	PLD 182.1 NT + BST 182 V/S + connecting adapter, without drill bit





Now up to 202 mm
drilling diameter



Ø 202



SPECIFICATIONS	DB 201
Power input	2500 W
Rated voltage	230 V ~
No-load speed	675 rpm
Drilling diameter	202 mm
Spindle connection	G½" female + 1¼" male
Column length	790 mm
Hub	550 mm
Weight	15.5 kg
Order no.	0B33R000
Supplied	in a box without accessories

Diamond core drilling unit DB 201

The compact unit for drilling up to Ø 202 mm

APPLICATION:

- Wet drilling in reinforced concrete, natural stone and asphalt
- Sanitary, heating and ventilation construction, civil engineering, landscape construction

FEATURES:

- Switch with over current cut-off – protection against overloading of the motor, cut off carbon brushes
- 1-speed oil bath gearbox – optimal lubrication
- Mechanical safety clutch
- Integrated water supply
- Stainless steel-combination spindle for connecting to 1½" and 1¼" drill bits
- Motor and rig as a complete unit
- Handy, robust and economical
- Space-saving, compact drilling unit – low weight



Diamond core drilling unit DBE 182

The unit for drilling up to Ø 202 mm

APPLICATION:

- Wet drilling in reinforced concrete, natural stone and asphalt
- Electrical installation, sanitary and heating installations, civil engineering, industrialised building

FEATURES:

- Electronic – soft start, temperature control and over current cut-off, overload indication, constant speed
- Service indicator – lights up approx. 10 working hours before the cut off carbon brushes need to be replaced
- 3-speed oil bath gearbox – for optimal lubrication in all working positions due to the specially developed oil pump and optimal adjusted torque-speed-ratio for all diameters
- Mechanical safety clutch
- Combination spindle with integrated connection for centering rod – fast, precise spot drilling
- PUR-construction site cable – strong for heavy duty use
- Integrated levels on machine and on the carriage, scale and hole center indicator on the drill rig – exact drilling
- Quick-mounting system – apply the motor to the drill rig without the need for tools
- Column of the rig can be adjusted to 45°
- Compact combination base – fixing with anchor or vacuum (vacuum set necessary)
- Feed lever change without any tools – easy change of the working site
- Retrofittable wheel axle (accessory) – easy transport



SPECIFICATIONS	DBE 182
Power input	2300 W
Rated voltage	230 V ~
Rated- /No-load speed	480/1080/2350 rpm
Drilling diameter	12-202 mm (optimal 182 mm)
Spindle connection	G½" female + 1¼" male
Column length	995 mm
Hub	700 mm
Weight	20.7 kg
Order no.	03E34000
Supplied	EBM 182/3 + BST 182 V/S without drill bit

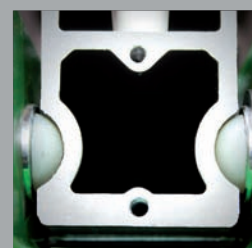

BST 182 V/S:
mounted carriage on 4 special balls



Ø 252



SPECIFICATIONS

DBE 250 R

Power input	2500 W
Rated voltage	230 V ~
Rated- /No-load speed	360/850 rpm
Drilling diameter	52-252 mm
Spindle connection	1 1/4" male
Column length	995 mm
Hub	600 mm
Weight	26.0 kg

Order no. 03521000

Supplied EBM 250/2 RP + BST 250 without drill bit

Diamond core drilling unit DBE 250 R

The unit for drilling up to Ø 252 mm

APPLICATION:

- Wet drilling in reinforced concrete, natural stone and asphalt
- Electrical installation, sanitary and heating installations, civil engineering, industrialised building

FEATURES:

- Electronic – soft start, temperature control and over current cut-off, overload indication, constant speed
- Mechanical oil bath gearbox – for optimal lubrication in all working positions due to the specially developed oil pump and optimal adjusted torque-speed-ratio for all diameters
- Mechanical safety clutch
- PUR-construction site cable – strong for heavy duty use
- Shaft seals replaceable from the outside – easy to service
- Integrated levels on the carriage, scale and hole center indicator on the drill rig – exact drilling
- Quick-change plate – easy assembly to the drill rig
- Column of the rig can be adjusted to 45°
- Feed lever change without any tools – easy change of the working site
- Retrofitable wheel axle (accessory) – easy transport



Diamond core drilling unit DBE 352

The powerful unit for drillings up to Ø 352 mm

APPLICATION:

- Wet drilling in reinforced concrete, natural stone and asphalt
- Civil engineering

FEATURES:

- Powerful 3000 W motor with high power reserves and a long lifetime
- Electronic – soft start, temperature control and over current cut-off, overload indication, constant speed
- Service indicator – lights up approx. 10 working hours before the cut off carbon brushes need to be replaced
- 3-speed oil bath gearbox – for optimal lubrication in all working positions due to the specially developed oil pump and optimal adjusted torque-speed-ratio for all diameters
- Mechanical safety clutch
- PUR-construction site cable – strong for heavy duty use
- Universal tool holder – fasten the motor to the drill rig without any tools
- Integrated levels on the carriage, scale and hole center indicator on the drill rig – exact drilling
- Column of the rig can be adjusted to 45°
- Compact combination base – fixing with anchor or vacuum (vacuum set necessary)
- Feed lever change without any tools – easy change of the working site
- Removeable wheel axle – easy transport



SPECIFICATIONS	DBE 352
Power input	3000 W
Rated voltage	230 V ~
Rated- /No-load speed	230/500/1030 rpm
Drilling diameter	42-352 mm
Spindle connection	1¼" male
Column length	995 mm
Hub	620 mm
Weight	35.0 kg
Order no.	03642000
Supplied	EBM 352/3 + BST 352 V without drill bit

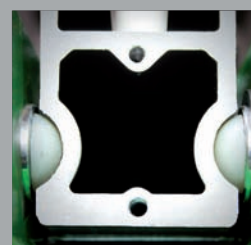

BST 352 V:
mounted carriage on 4 special balls



PowerLine

Optimized performance
with strong motor



Ø452



SPECIFICATIONS	PLE 450 B
Power input	3300 W
Rated voltage	230 V ~
Rated speed	180/400/780 rpm
No-load speed	300/650/1300 rpm
Drilling diameter	71-452 mm
Spindle connection	1¼" male
Column length	960 mm
Hub	620 mm
Weight	35.8 kg
Order no.	0373B000
Supplied	PLD 450.1 B + PLB 450 without drill bit

Diamond core drilling unit PLE 450 B

The robust, powerful unit for drillings up to Ø 452 mm

APPLICATION:

- Wet drilling in reinforced concrete, natural stone and asphalt
- Drilling operators, civil engineering

FEATURES:

- Powerful 3300 W heavy-duty motor with high power reserves and a long lifetime
- Full aluminium housing – durable and resistant
- Electronic – soft start, over current cut-off, overload indication
- 3-speed oil bath gearbox – for optimal lubrication in all working positions due to the specially developed oil pump and optimal adjusted torque-speed-ratio for all diameters
- Mechanical safety clutch
- PUR-construction site cable – strong for heavy duty use
- Universal tool holder – fasten the motor to the drill rig without any tools
- Integrated levels on the carriage and scale on the drill rig – exact drilling
- Column swivel in three levels (75°/60°/45°)
- Steel column – robust, stable, buckling resistant
- Tooth rail separately exchangeable – easy to maintain
- Compact base with cut-out for quick action bracing unit
- Feed lever change without any tools – easy change of the working site
- Removeable wheel axle – easy transport

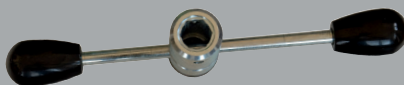

all adjusting elements with wrench size 19 mm:
easy adjustment/fixation with the feed lever



DIAMOND DRILL BITS

Diameter	Usable length	Segments		Diameter	Usable length	Segments			
Drill bit for socket outlets M 16 – dry – brickwork, sand-lime brick									
A	Ø 68 mm	70 mm	3	35473000	J	Ø 161 mm	450 mm	12	36316100
	Ø 82 mm	70 mm	5	35471000		Ø 171 mm	450 mm	12	36317100
B	Ø 68 mm	70 mm	3	35474000		Ø 181 mm	450 mm	13	36318100
	Ø 82 mm	70 mm	5	35472000		Ø 201 mm	450 mm	14	36320100
C	Ø 68 mm	70 mm	3	35475000		Ø 211 mm	450 mm	15	36321100
	Ø 82 mm	70 mm	5	35476000		Ø 225 mm	450 mm	15	36322500
Drill bit for socket outlets M 16 – dry – hard sand-lime brick									
C	Ø 82 mm	70 mm	4	35478000		Ø 250 mm	450 mm	16	36325000
Diamond dry drill bits 1¼" – brickwork, sand-lime brick									
D	Ø 82 mm	200 mm	5	36A08200		Ø 257 mm	450 mm	16	36325700
	Ø 112 mm	200 mm	5	36A11200	Ø 300 mm	450 mm	24	36330000	
	Ø 132 mm	200 mm	6	36A13200	Ø 350 mm	450 mm	28	36335000	
	Ø 152 mm	200 mm	6	36A15200	Ø 400 mm	450 mm	32	36340000	
	Ø 162 mm	200 mm	7	36A16200	Ø 450 mm	450 mm	33	36345000	
	Ø 172 mm	200 mm	7	36A17200	Diamond wet full drill bits M 12 – concrete, tiles				
	Ø 182 mm	200 mm	8	36A18200	K	Ø 6 mm	150 mm		36120600
	Ø 192 mm	200 mm	8	36A19200		Ø 8 mm	150 mm		36120800
	Ø 202 mm	200 mm	10	36A20200		Ø 10 mm	150 mm		36121000
	E	Ø 225 mm	200 mm	12	36A22500	L	Ø 12 mm	150 mm	
Ø 250 mm		200 mm	12	36A25000	Ø 3.5 mm		60 mm		36110300
Ø 52 mm		420 mm	3	36505200	Ø 4 mm		60 mm		36110400
Ø 62 mm		420 mm	3	36506200	Ø 5 mm		60 mm		36110500
Ø 72 mm		420 mm	4	36507200	Ø 6 mm		60 mm		36110600
Ø 82 mm		420 mm	5	36508200	Ø 8 mm		60 mm		36110800
Ø 102 mm		420 mm	5	36510200	Ø 10 mm	60 mm		36111000	
Ø 112 mm		420 mm	5	36511200	Ø 12 mm	60 mm		36111200	
Ø 122 mm		420 mm	6	36512200	Diamond wet hollow drill bits M 12 – stoneware, natural stone				
Ø 127 mm		420 mm	6	36512700	M	Ø 6 mm	60 mm	Ring	36130600
Ø 132 mm	420 mm	6	36513200	Ø 8 mm		60 mm	Ring	36130800	
Ø 152 mm	420 mm	6	36515200	Ø 10 mm		60 mm	Ring	36131000	
Ø 162 mm	420 mm	7	36516200	Ø 12 mm		60 mm	Ring	36131200	
Ø 172 mm	420 mm	7	36517200	Ø 14 mm		60 mm	Ring	36131400	
Ø 182 mm	420 mm	8	36518200	Ø 16 mm		60 mm	Ring	36131600	
Ø 202 mm	420 mm	10	36520200	Ø 18 mm	60 mm	Ring	36131800		
Ceramic drill bit 1¼" – ceramics									
F	Ø 182 mm	150 mm	Ring	36418200	Diamond wet drill bits R½" – tiles, stoneware, natural stone				
Diamond dry drill bits M 16 – reinforced concrete, sand-lime brick									
G	Ø 52 mm	150 mm	7	36S05100	N	Ø 22 mm	40 mm	Ring	38102200
	Ø 68 mm	150 mm	10	36S06700		Ø 30 mm	40 mm	Ring	38103000
	Ø 82 mm	150 mm	11	36S08100		Ø 35 mm	40 mm	Ring	38103500
Diamond wet drill bits R½" – reinforced concrete, brickwork									
H	Ø 10 mm	300 mm	Ring	36201000		Ø 40 mm	40 mm	Ring	38104000
	Ø 12 mm	300 mm	Ring	36201200		Ø 45 mm	40 mm	Ring	38104500
	Ø 14 mm	300 mm	Ring	36201400		Ø 50 mm	40 mm	Ring	38105000
	Ø 16 mm	300 mm	Ring	36201600		Ø 55 mm	40 mm	Ring	38105500
	Ø 18 mm	300 mm	Ring	36201800		Ø 60 mm	40 mm	Ring	38106000
	Ø 20 mm	300 mm	Ring	36202000		Ø 63 mm	40 mm	Ring	38106300
	Ø 25 mm	300 mm	Ring	36202500		Ø 68 mm	40 mm	Ring	38106800
	Ø 31 mm	300 mm	Ring	36203100		Ø 76 mm	40 mm	Ring	38107600
	Ø 38 mm	420 mm	Ring	36203800	Ø 82 mm	40 mm	Ring	38108200	
	I	Ø 41 mm	420 mm	4	36204100	Ø 102 mm	40 mm	Ring	38110200
Ø 51 mm		420 mm	5	36205100	Ø 122 mm	40 mm	Ring	38112200	
Diamond wet drill bits 1¼" – reinforced concrete, brickwork									
J	Ø 166 mm	140 mm	12	36B16600	Diamond wet drill bits R½" – natural stone				
	Ø 186 mm	140 mm	13	36B18600	O	Ø 18 mm	150 mm	Ring	36C01800
	Ø 201 mm	140 mm	14	36B20100		Ø 25 mm	150 mm	Ring	36C02500
	Ø 41 mm	450 mm	4	36304100		Ø 35 mm	150 mm	Ring	36C03500
	Ø 51 mm	450 mm	5	36305100		Ø 51 mm	150 mm	Ring	36C05100
	Ø 61 mm	450 mm	6	36306100	Drill bit extensions R½" for drill bits from Ø 31 mm				
	Ø 71 mm	450 mm	6	36307100	Ø 30 mm	200 mm		35462000	
	Ø 81 mm	450 mm	7	36308100	Ø 30 mm	300 mm		35463000	
	Ø 91 mm	450 mm	8	36309100	Ø 30 mm	500 mm		35465000	
	Ø 101 mm	450 mm	9	36310100	Drill bit extensions 1¼" for drill bits from Ø 51 mm				
	Ø 106 mm	450 mm	9	36310600	Ø 47 mm	200 mm		35452000	
	Ø 111 mm	450 mm	9	36311100	Ø 47 mm	300 mm		35453000	
	Ø 121 mm	450 mm	10	36312100	Ø 47 mm	400 mm		35454000	
	Ø 126 mm	450 mm	10	36312600	Ø 47 mm	500 mm		35455000	
	Ø 131 mm	450 mm	10	36313100	Diamond dry drill bits, M 14 (EFB 68)				
Ø 141 mm	450 mm	11	36314100	P	Ø 20 mm	35 mm	Ring	38202000	
Ø 151 mm	450 mm	11	36315100		Ø 35 mm	35 mm	Ring	38203500	
					Ø 40 mm	35 mm	Ring	38204000	
				Ø 50 mm	35 mm	Ring	38205000		
				Ø 68 mm	35 mm	Ring	38206800		
				Diamond dry drill bits-set, M 14 (EFB 68)					
				Ø 35, 40, 50, 68 mm	60 mm	Ring	38200100		

DIAMOND CORE DRILLING



Diamond core drilling units ACCESSORIES

H I J

**Diamond drill bits and
drill bit extensions**
see page 53



e.g. 1 1/4", Ø 47 mm x 500 mm

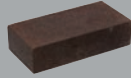

Sharpening block
200 x 100 x 50 mm

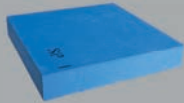

Sharpening plate
320 x 320 x 55 mm

Copper ring 1 1/4"
for easy removal of the drill bit
1 piece

Slider quick release ring 1 1/4"
for drill bits
1 piece

Dust extraction
1 1/4" f-1 1/4" m



Water tank
5 l plastic
incl. 4.0 m hose
with Gardena-Connector

10 l metal
incl. 3.5 m hose
with Gardena-Connector

Quick action bracing unit
1.7-3 m Hub



Wheel axle
for BST 182 V/S, BST 250



Tightening screw
with wing nut, washer,
1 dowel M 12, Ø 16 mm

Fastening set concrete/stone
10 dowels M12, Ø 16 mm,
tightening screw,
wing nut, washer,
1 punch bolt

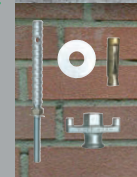

Fastening set brickwork
dowel M 12, Ø 20 mm,
tightening screw,
wing nut, washer

Dry drilling

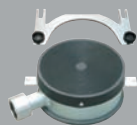

Water suction ring

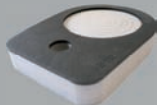

Water suction ring
WR 32-152



Spare seal
for Water suction ring



Vacuum plate
for KBS 250



Vacuum plate
for BST 250, 300, PLB 450



Vacuum set
for BST 182 V/S, BST 352 V



Vacuum hose
Length 3 m



Industrial vacuum cleaner



Vacuum pump VP 03
Duty: 25 l/min,
Max. drilling-Ø: 150 mm,
Max. vacuum: 850 mbar



Vacuum pump VP 04
Duty: 100 l/min,
Max. vacuum: 900 mbar

A Drill rigs and diamond core drilling units ACCESSORIES

		BST 50 V	BST 90	KBS 250	BST 182 V/S	BST 250	BST 352 V	PLB 450	PLB 450 G	DBE 162	PLE 182	DB 200	DBE 182	DBE 250	DBE 352	PLE 450 B
Core drill motor ETN 162/3	03E31000				x					x						
Core drill motor PLD 182	0343X000				x						x					
Core drill motor EBM 182/3	03E33000				x								x			
Core drill motor EBM 250/2 RP	0352H000					x	(x)	(x)	(x)					x		
Core drill motor EBM 352/3	03641000					(x)	x	(x)	(x)						x	
Core drill motor PLD 450.1 B	0373C000					(x)	(x)	x	x							x
Copper ring 1¼"	35450000				x	x	x	x	x	x	x	x	x	x	x	x
Slider quick release ring 1¼"	35652000				x	x	x	x	x	x	x	x	x	x	x	x
Dust extraction 1¼" f-1¼" m	35231000				x	x						x	x	x		
Fastening set concrete/stone	35720000		x	x	x	x	x	x	x	x	x	x	x	x	x	x
Dowels for concrete/stone	35722000		x	x	x	x	x	x	x	x	x	x	x	x	x	x
Tightening screw	35721000		x	x	x	x	x	x	x	x	x	x	x	x	x	x
Fastening set brickwork	35724000		x	x	x	x	x	x	x	x	x	x	x	x	x	x
Dowel for brickwork	35725000		x	x	x	x	x	x	x	x	x	x	x	x	x	x
Quick action bracing unit	35730000		x	x	x	x	x	x	x	x	x	x	x	x	x	x
Wheel axle	3582B000				x					x	x		x			
Wheel axle	3582C000					x								x		
Water tank 5 l	35811000	x	x	x	x	x	x	x	x	x	x	x	x	x	x	x
Water tank 10 l	35812000	x	x	x	x	x	x	x	x	x	x	x	x	x	x	x
Water suction ring WR 32-152	35874000	Ø 32, 52, 82, 102, 122, 152 mm (also usable in manual mode)														
Water suction ring WR 160	35875000											x				
Water suction ring WR 202	3587C000				x					x	x		x			
Water suction ring WR 300	35879000					x								x		
Water suction ring WR 352	35873000						x								x	
Water suction ring WR 350 PL	3587Y000							x ¹								x
Water suction ring WR 350.1 PL	3587L000							x ²	x							x
Spare seal ED 152	3586A000											x				
Spare seal ED 202	3586K000				x					x	x		x			
Spare seal ED 300	35868000					x								x		
Spare seal ED 352	3586L000						x	x	x						x	x
Industrial vacuum cleaner DSS 25 A	09915000		x	x	x	x	x	x	x	x	x	x	x	x	x	x
Industrial vacuum cleaner DSS 50 A	09916000		x	x	x	x	x	x	x	x	x	x	x	x	x	x
Vacuum plate	35851000			x								x				
Vacuum set	35854000		x													
Vacuum set	3585F000				x					x	x		x			
Vacuum set	3585G000						x								x	
Vacuum hose	35855000		x	x	x	x	x	x	x	x	x	x	x	x	x	x
Vacuum pump VP 03	09201000		x	x	x					x	x	x	x			
Vacuum pump VP 04	09204000		x	x	x	x	x	x	x	x	x	x	x	x	x	x
Sharpening block	35910000	x	x	x	x	x	x	x	x	x	x	x	x	x	x	x
Sharpening plate	35913000	x	x	x	x	x	x	x	x	x	x	x	x	x	x	x
Reducing ring Ø 60 - Ø 53 mm	35820000			x												
Reducing ring Ø 60 - Ø 43 mm	35821000			x												
Connecting adapter universal tool holder/collar Ø 60 mm	35829000				x	x	x				x					

(x) limited suitability X¹ until year of manufacture 2016 X² from year of manufacture 2017



Ø 68



DUST PROTECTION SYSTEM

Mineral dust may cause cancer!

SPECIFICATIONS

EFB 68

Power input	1400 W
Rated voltage	230 V ~
Rated- /No-load speed	3000-10000 rpm
Drilling diameter	20-68 mm
Spindle connection	M 14 male
Weight	3.5 kg
Order no.	0662H000
Supplied	in a box, without drill bit



Protection of the user against dangerous mineral dust by suction, in comparison to conventional methods with angle grinder



Precise drilling due to non-slip foam material no slipping of the drill bit



Tile drilling machine
EFB 68

NEW

The precise and low-dust Tile drilling machine

APPLICATION:

- Dry drilling of granite, tiles and slabs of ceramic materials and natural stone
- Production of drillings for fittings and pipe penetrations, built-in lights, switches, etc.
- Tiler, natural stone company

FEATURES:

- Exact positioning of the machine by support hood + LED light
- Electronic - soft start, speed control and -constant maintenance



Tile drilling machine EFB 68 ACCESSORIES

P

Diamond dry drill bits, M 14

Ø	Usable Length	Segments	Order no.
20 mm	35 mm	Ring	38202000
35 mm	35 mm	Ring	38203500
40 mm	35 mm	Ring	38204000
50 mm	35 mm	Ring	38205000
68 mm	35 mm	Ring	38206800

Diamond dry drill bits Set, M 14

35, 40, 50, 68 mm	35 mm	Ring	38200100
-------------------	-------	------	----------

Foam ring

Ø 149 mm			38011000
----------	--	--	----------



Exact positioning of the machine by supporting hood & LED light

Dry drilling with dust extraction of granite, tiles and slabs of ceramic materials and natural stone in the interior directly on site, saves long ways



Speed control
Speed adjustment to the respective drill bit size



Suction device
for almost dust-free working



Simple drill bit change





Tile drilling machine EFB 152 PX



Ø 120

Precise drilling with minimum effort

APPLICATION:

- Wet drilling of tiles and plates of ceramic materials, glass and natural stone
- Producing of holes for armature and toilet installations, recessed lights, switches etc.
- Tilers, natural stone companies

FEATURES:

- Electronic – soft start, temperature control and over current cut-off, speed regulation and constant speed
- Integrated water supply
- Drilling of large tiles possible without the use of the pan
- Detachable machine and removable pan with water drain allow – easy cleaning, easily transportable, stable design
- Galvanised support – rust resistant
- Splash protector – height adjustable for different material thicknesses without the need for any tools

SPECIFICATIONS

EFB 152 PX

Power input	1150 W
Rated voltage	230 V ~
Rated- /No-load speed	250-1000 rpm
Drilling diameter	6-120 mm
Distance column / drill bit middle	320 mm
Spindle connection	G½" female
Weight	19.0 kg
Order no.	0662B000
Supplied	in a box incl. assembly tools, without drill bit without quick change adapter



A Tile drilling machine ACCESSORIES

	1	Adapter ring for fixing to small tiles from 10 cm	38003000
	2	Diamond wet drill bits G½" see page 53 max. drilling depth 40 mm for tiles, stoneware, natural stone	
	3	Folding table with board B 400 x L 600 x H 850 mm	37473000
	4	Sharpening block 200 x 100 x 50 mm	35910000
	5	Quick change adapter	38004000
	6	Quick change attachment	38006000
	7	Water suction ring WR 130	38007000



MIXING





Model		Page	Max. basket diameter	Spindle connection	Power input	Rated speed
EHR 14.1 SK 07753000		62	120 mm	M 14 female	960 W	0-390 rpm
EHR 15.2 SB 077E5000		62	120 mm	M 14 female	1050 W	0-450 rpm
EHR 18.1 S 077E1000		63	120 mm	M 14 female	1100 W	0-450 rpm
EHR 20.1 R 07742000		63	140 mm	M 14 female	1300 W	250-580 rpm
EHR 20/2.6 S 077E2000		64	140 mm	M 14 female	1300 W	0-250/ 0-450 rpm
EHR 23/2.5 S 077E3000		64	180 mm	M 14 female	1800 W	0-250/ 0-580 rpm
EHM 162 S Set 07779000		65	180 mm	M 14 female	2000 W	0-430 rpm
EZR 24 R R/L 0774W000		65	230 mm	Special	1800 W	180-440 rpm
EHR 750 B 07B11000		66	140 mm	M 14 female	750 W	450 rpm
TwinMix 1800 T 07623000		70	–	M 14/Special	1800 W	250/450 rpm 20/36 rpm
FloorMix 2300 07625000		72	–	M 16 female	2300 W	70/130/160/ 280 rpm
Automix 1801 07614000		74	–	M 20 female	1500 W	50 rpm
Automix 90 07617000		74	–	M 20 female	1500 W	50 rpm



FEATURES OF STIRRERS

From the small, handy mixer up to the mobile mixing station. Our reliable, well made, durable and easy to use EIBENSTOCK mixing range has something for everyone in the plastering, painting and masonry trades.

We offer a quick change paddle adaptor with M14 thread for the entire range as an accessory.



Stirrer EHR 14.1 SK Set



max. 120 >>> 1 >>>

The lightweight up to 30 kg

APPLICATION:

- Mixing of building materials with low viscosity, e.g. paint, glue, filler and leveling compounds, tile cement
- Drywall construction, tiler, painter and plasterer

FEATURES:

- Electronic switch – stepless speed control for less splashing
- Large handles – effortless working
- T-wise handling – comfortable mixing

Stirrer EHR 15.2 SB Set



max. 120 >>> 1 >>>

The handy up to 40 kg

APPLICATION:

- Mixing of building materials with low and middle viscosity, e.g. paint, glue, filler and leveling compounds, tile cement, ready-mixed mortar
- Drywall construction, tiler, painter and plasterer

FEATURES:

- Electronic switch – stepless speed control for less splashing
- Space-saving metal bow handle – handy, easy to put down, comfortable transport
- Soft grip handle – less vibration, non-slip

SPECIFICATIONS	EHR 14.1 SK SET
Power input	960 W
Rated voltage	230 V ~
Rated speed	0-390 rpm
No-load speed	0-590 rpm
Max. basket diameter	120 mm
Spindle connection	M 14 female
Weight	2.9 kg
Order no.	07753000

Supplied in a box
incl. stirring rod WG 120

SPECIFICATIONS	EHR 15.2 SB SET
Power input	1050 W
Rated voltage	230 V ~
Rated speed	0-450 rpm
No-load speed	0-800 rpm
Max. basket diameter	120 mm
Spindle connection	M 14 female
Weight	3.1 kg
Order no.	077E5000

Supplied in a box
incl. stirring rod WG 120



Stirrer EHR 18.1 S Set



max. 120

Stirrer EHR 20.1 R Set



max. 140



The universal up to 40 kg

APPLICATION:

- Mixing of building materials with low and middle viscosity, e.g. paint, glue, filler and leveling compounds, tile cement, ready-mixed mortar
- Drywall construction, tiler, painter and plasterer, civil engineering

FEATURES:

- Dust protected electronic switch – stepless speed control for less splashing
- Cap with labyrinth-guide
- Damping and protection elements

The perfect adjustable up to 50 kg

APPLICATION:

- Mixing of building materials with middle and high viscosity, e.g. filler and leveling compounds, tile cement, ready-mixed mortar and plaster
- Drywall construction, plaster, civil engineering, landscaping

FEATURES:

- Dust protected switch – soft start for less splashing
- Temperature control
- Stepless speed regulation and constant speed – optimum settings on the material to be mixed
- Cap with labyrinth-guide
- Damping and protection elements

SPECIFICATIONS	EHR 18.1 S SET
Power input	1100 W
Rated voltage	230 V ~
Rated speed	0-450 rpm
No-load speed	0-800 rpm
Max. basket diameter	120 mm
Spindle connection	M 14 female
Weight	4.1 kg
Order no.	077E1000
Supplied	in a box incl. stirring rod WG 120

SPECIFICATIONS	EHR 20.1 R SET
Power input	1300 W
Rated voltage	230 V ~
Rated- /No-load speed	250-580 rpm
Max. basket diameter	140 mm
Spindle connection	M 14 female
Weight	4.9 kg
Order no.	07742000
Supplied	in a box incl. stirring rod MG 140





Stirrer EHR 20/2.6 S Set



max. 140 

The versatile up to 50 kg

APPLICATION:

- Mixing of building materials with middle and high viscosity, e.g. filler and leveling compounds, tile cement, ready-mixed mortar and plaster, screed
- Drywall construction, tiler, plaster, civil engineering, landscaping

FEATURES:

- Dust protected electronic switch – stepless speed control for less splashing
- 2-speed gearbox – the right speed for every application
- Cap with labyrinth-guide
- Damping and protection elements

Stirrer EHR 23/2.5 S Set



max. 180 

The powerful up to 80 kg

APPLICATION:

- Mixing of building materials with high viscosity, e.g. filler and leveling compounds, tile cement, ready-mixed mortar and plaster, screed, epoxy resins, sealants, granules
- Drywall construction, tiler, plaster, civil engineering, landscaping

FEATURES:

- Dust protected electronic switch – stepless speed control for less splashing
- 2-speed gearbox – the right speed for every application
- Cap with labyrinth-guide
- Damping and protection elements

SPECIFICATIONS	EHR 20/2.6 S SET
Power input	1300 W
Rated voltage	230 V~
Rated speed	0-250/0-450 rpm
No-load speed	0-400/0-730 rpm
Max. basket diameter	140 mm
Spindle connection	M 14 female
Weight	5.1 kg
Order no.	077E2000
Supplied	in a box incl. stirring rod MG 140

SPECIFICATIONS	EHR 23/2.5 S SET
Power input	1800 W
Rated voltage	230 V~
Rated speed	0-250/0-580 rpm
No-load speed	0-440/0-970 rpm
Max. basket diameter	180 mm
Spindle connection	M 14 female
Weight	6.9 kg
Order no.	077E3000
Supplied	in a box incl. stirring rod MG 160



Stirrer EHM 162 S Set

Contra twin stirrer EZR 24 R R/L Set



max. 180°



Powerful
with new gearbox

230°

The robust up to 80 kg

APPLICATION:

- Mixing of building materials with high viscosity, e.g. filler and leveling compounds, tile cement, ready-mixed mortar and plaster, screed, epoxy resins, sealants, granules
- Drywall construction, tiler, plaster, civil engineering, landscaping

FEATURES:

- powerful engine
- side handle (can be used on both sides) - safe handling of highly viscous material
- electronic switch – stepless speed control for less splashing
- Space-saving metal bow with soft grip handle handy, vibration damping, non-slip, easy to lay down, convenient to transport

Mixing of most difficult and multi- component materials up to 80 kg

APPLICATION:

- Mixing clockwise of highly viscous and stiff materials, e.g. tile cement, ready-mixed mortar and plaster, screed, epoxy resins, sealants, granules, multi-component materials, coatings
- Mixing anticlockwise of building materials with low and middle viscosity, e.g. paint, glue, filler and leveling compounds
- Drywall construction, tiler, painter and plasterer, civil engineering, floor renovators

FEATURES:

- Two mixing effects simply by switching
- Two contra rotating stirring rods – no counter torque, easy handling, saves time and effort
- Electronic switch – dust protected
- Soft start for less splashing
- Temperature control
- Soft start, speed regulation and constant speed

SPECIFICATIONS	EHM 162 S SET
Power input	2000 W
Rated voltage	230 V~
Rated speed	0-430 rpm
No-load speed	0-800 rpm
Total diameter rods	180 mm
Spindle connection	M 14 female
Weight	6.0 kg
Order no.	07779000
Supplied	in a box incl. stirring rod MG 160

SPECIFICATIONS	EZR 24 R R/L SET
Power input	1800 W
Rated voltage	230 V~
Rated- /No-load speed	180-440 rpm
Total diameter rods	230 mm
Spindle connection	Special
Weight	7.1 kg
Order no.	0774W000
Supplied	in a box incl. stirring rods Z 230





**Powerful and high-torque
as alternative to battery mixer**



incl. extension 150 mm



80 kg

SPECIFICATIONS	EHR 750 B
Engine/Capacity	4-stroke petrol engine/31 cc
Max. engine power	0.75 kW/1.0 hp
Rated speed	0-450 rpm
Max. basket diameter	140 mm
Spindle connection	M 14 female
Weight	8.9 kg
Order no.	07B11000
Supplied	in a box incl. stirring rod MG 140 and extension 150 mm

Petrol stirrer EHR 750 B

The cordless freedom when mixing outdoor

APPLICATION:

- Mains and current-independent mixing of building material with medium and high viscosity, e.g. glue, ready-mixed mortar and plaster, screed
- Saves the use of generators at places without electricity
- Substantially more powerful than battery mixers at longer mixing times
- Gardening and landscaping, road construction, railway, municipal enterprises, civil engineering in general

FEATURES:

- 4-stroke petrol-powered engine
- Quick start, electronic ignition
- In comparison to 2-stroke engines smooth running, environmentally-friendly, lower emissions and lower fuel consumption

comparison of cordless alternatives petrol vs. battery

acquisition costs

stirrer, petrol

stirrer, 2 battery pack, charger

max. quantity of mixed material

up to approx. 80 kg

up to approx. 30 kg

mixing time

about 60 min mixing time/0,75l petrol

about 10 min mixing time/battery pack

**Where the battery fails
and power is needed:
mixing independent of electric
power also for large quantities
of tough materials**





MIXING



THE FEATURES OF THE STIRRERS OF THE NEW GENERATION



Damping and protection elements made of polyurethane – protection of the machine and the surface in case of unintentional fall



Dust protected electronic switch, PUR-construction site cable and a protected cable outlet



Wide, trapezium design, ergonomic handles and balanced center of gravity – easy, well balanced guiding of the machine for greater leverage



Extensions and quick change adapters allow the user to easily change the stirring rod and adapt the stirrer to the users size, without the need for tools.





- **Separation without the need for tools***
into 3 components,
space-saving storage/transport

Universal motor
powerful, robust,
high torque

Protective grating*
easy and safe pouring into
bucket

Safety switch
cut-off in case of opening the
protective grating – protec-
tion of the user

Draught-bar
Integrated transport cart
with draught-bar– mobile use of
the bucket

Transport rollers
for mobile use

** not present on all models*

FEATURES OF MIXING STATIONS

Our mobile mixing stations offer a compact size and low weight but also maintain high torque.

The drive motor can be removed quickly and effortlessly to allow easy transport of the unit whilst also saving space.



Patented system
Innovative drive solution:
one motor – two contra
rotating mixing tools



Timer for setting the
requested mixing time
(accessory for TwinMix 1800 T)

50 kg



SPECIFICATIONS

TWINMIX 1800 T

Power input	1800 W
Rated voltage	230 V ~
Rated- /No-load speed mixing rod	250/450 rpm
Rated- /No-load speed mixing paddle	20/36 rpm
Bucket size	65 l
Spindle connection	M 14/Special
Weight	70.0 kg
Order no.	07623000
Supplied	on a pallet incl. mixing rod, mixing paddle, bucket 65 l and transport carriage

Mixing station TwinMix 1800 T

The mobile station for thorough mixing with a wide range of application

APPLICATION:

- Homogeneous and lump free mixing of numerous materials with different viscosity
- Especially convenient for the mixing of self-levelling floor levelling compounds, plaster, thin-bed mortar, fillers
- Building construction and civil engineering, landscaping, floor renovators, tilers

FEATURES:

- Mixing paddle with scraper – avoids material deposits on the bucket rim and ensures together with a fast running inner rod a better mixing
- Two electronic speed levels – start mixing function with reduced speed
- Transport carriage with handles and big wheels – mobile use of the station at the construction sites, also at rough terrain
- Robust universal motor – very high pulling power
- Electronic – soft start, constant speed, temperature control and over current cut-off
- Switch with dust protection and protection against re-start
- Safety Switch – cut-off in case of opening the hood, protection of the operator
- Connection for dust exhaust Ø 35 mm as well as funnel tube with brushes – dust reduced filling and mixing of the materials
- Tipper (accessory) especially designed for clean and precise pouring of self-levelling filler and levelling compounds
- Mixing carriage (supplied) can be used separate from the station – flexible and mobile at the job site

ACCESSORIES



Transport carriage with 2 big wheels
 Order no.: 09Z11000



Tipper with 4 wheels (2 steerable)
 Order no.: 09Z12000



Timer for TwinMix 1800 T
 Order no.: 32352000



Bucket 65 l
 Order no.: 32341000



Fast, uninterrupted work when using several mixing carriages, f. e. for levelling filler

- ⇒ saves time and costs
- ⇒ reduces the risk that the material is setting too fast in wet-on-wet cycle

 saves at least **50% time**

10:15



10:20



VERSATILE APPLICATION POSSIBILITIES



masonry mortar



thin-bed mortar



plaster



floating screed



tile cement



two-component materials



insulation board adhesive



screed



filler

Health protecting mixing (dust reduced construction site, especially in the interior)

- ⇒ Hazardous dust (e. g. silica dust) has to be suctioned by a Dust Class M Vacuum Cleaner! For our electric power tools we are recommending to use a Vacuum Cleaner of our Eibenstock DSS range!

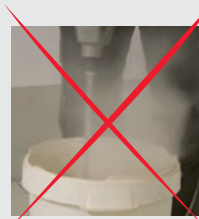



**Robust, powerful 2300 W motor –
very high performance**



**Four speed settings by 2-speed gearbox
AND two electronic speed levels –
optimal mixing results**

150kg



SPECIFICATIONS

FLOORMIX 2300

Power input	2300 W
Rated voltage	230 V ~
Rated- /No-load speed	70/130/160/280 rpm
Bucket size	110 l
Spindle connection	M 16 female
Weight	48.0 kg
Order no.	07625000
Supplied	on a pallet incl. special stirring rod and bucket 110 l

Mixing station FloorMix 2300

The mobile station with a large mixing volume up to 150 kg for high surface performance

APPLICATION:

- Homogeneous and lump free mixing of floating screed, leveling fillers, fiber-reinforced fillers, colored coatings, liquid plastics
- Optimally suited for low-viscosity flooring compounds
- Floor renovators, tilers

FEATURES:

- Special stirring rod avoids clumping and material deposits on the base and sides
- Electronic – soft start, constant speed, temperature control and over current cut-off
- Switch with dust protection and protection against re-start
- Start mixing function with reduced speed and optimal adjustment of the speed to the mixing material
- Drive unit with stirring rod can be separated from the carriage without any tools – easy to clean
- Well-balanced center of gravity – easy tipping and precise dosing
- Compact dimensions – easy maneuvering and pouring
- Pouring device – optimal disperse of the material
- Transport carriage with handles and big wheels – mobile use of the station at the construction sites
- 4 castors – move into all directions, highest mobility, pour and drive in one step
- Connection for dust exhaust Ø 35 mm – dust reduced filling and mixing of the materials

ACCESSORY



Bucket 110 l
Order no.: 32343000



Optimal mixing results:

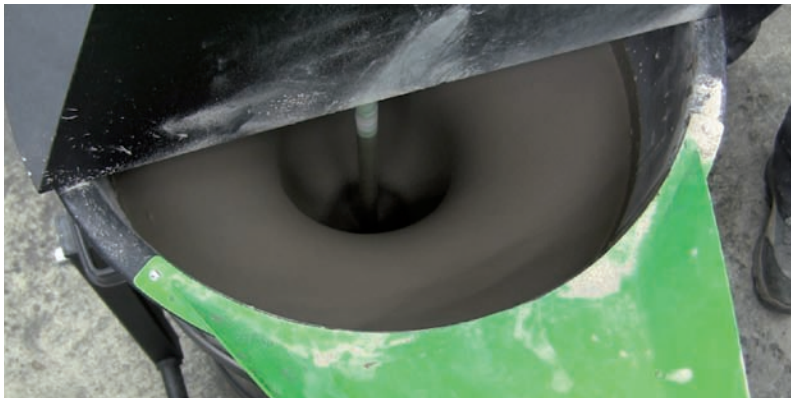

Effective working especially in wet-on-wet cycle:

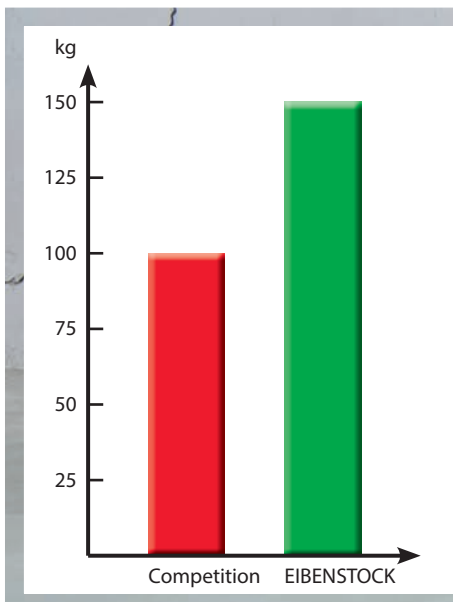

MIXING

Easy to clean:



Health protecting mixing (dust reduced construction site, especially in the interior)

⇒ Hazardous dust (e. g. silica dust) has to be suctioned by a Dust Class M Vacuum Cleaner! For our electric power tools we are recommending to use a Vacuum Cleaner of our Eibenstock DSS range!





Mixing station Automix 1801



50 kg

The mobile mixing station up to 50 kg

APPLICATION:

- Mixing of building materials with middle and high viscosity, e.g. filler and leveling compounds, tile cement, ready-mixed mortar and plaster, screed
- Civil engineering, floor renovators, landscaping

FEATURES:

- Robust universal motor – very high performance
- Dust protected switch
- Mechanical safety clutch
- Integrated transport cart with draught-bar – for mobile use
- Separation of motor and base frame without any tools
- Low weight, compact design – easy to transport and space-saving storage
- Protective grating – easy and safe pouring of bagged material
- Hinged machine arm – easy bucket exchange
- Twist protection for bucket – stable handling

Mixing station Automix 90



80 kg

The mobile mixing station up to 80 kg

APPLICATION:

- Mixing of building materials with middle and high viscosity, e.g. filler and leveling compounds, tile cement, ready-mixed mortar and plaster, screed
- Civil engineering, floor renovators, landscaping

FEATURES:

- Robust universal motor – very high performance
- Dust protected switch
- Mechanical safety clutch
- Integrated transport cart with draught-bar – for mobile use
- Separation of motor and base frame without any tools
- Space-saving storage
- Safety switch – cut-off in case of opening the protective grating
- Remix operator – pressing a special button enables to continue the mixing operation after the head has been lifted up
- Twist protection for bucket – stable handling

SPECIFICATIONS	AUTOMIX 1801
Power input	1500 W
Rated voltage	230 V ~
Rated speed	50 rpm
No-load speed	115 rpm
Bucket size	65 l
Spindle connection	M 20 female
Weight	26.5 kg
Order no.	07614000

Supplied in a box incl. mixing paddle and bucket 65 l

ACCESSORY Bucket 65 l [32341000](#)

SPECIFICATIONS	AUTOMIX 90
Power input	1500 W
Rated voltage	230 V ~
Rated speed	50 rpm
No-load speed	115 rpm
Bucket size	90 l
Spindle connection	M 20 female
Weight	35.0 kg
Order no.	07617000

Supplied in a box incl. special stirring rod

ACCESSORY Bucket 90 l [32342000](#)
Transport carriage (without bucket) [32331000](#)





M 14 male thread

max. power transmission,
high concentricity,
easy change,
non sensitive

or hexagonal shank

for wrench roundbar,
respectively for use with
standard drill chucks

Product information

with application
recommendation

Stirring bar

made of stable round bar steel
smooth surface
galvanised, high resistant, durable

Helix

robust welded joints

Ring*

for protection of bucket

* not present on all models

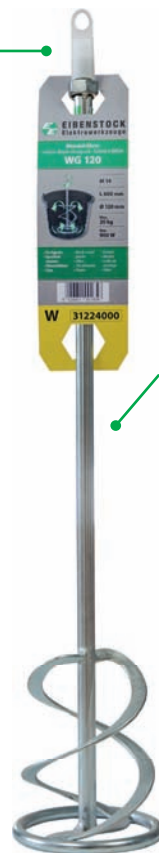

CHARACTERISTICS OF THE STIRRING RODS

EIBENSTOCK offers mixing paddles for all requirements and applications. They have a high concentricity and are extremely durable.



APPLICATIONS OF THE STIRRING RODS

S Disc stirring rod, galvanised

The stirring rod for liquid media for use with high-speed tools. Quick and smooth running mixing.

R Round stirring rod, galvanised

The stirring rod for liquid and viscous media, e.g. wall paints for inside and outside, emulsion paints, lacquers, zinc dust paints, mineral paints, silicate paints, cement paints, minium, chemicals, bitumen, casting compounds, laitances.

W Helicon ribbon stirring rod, galvanised

The powerful stirring rod for sticky and tough materials, e.g. prefab plaster and mortar, adhesive mortar, preparation binder, gypsum, lime, cement facing, screed, concrete, tile cement, bonding, pastes, granulates, quartz-filled epoxy resins.

M Mortar stirring rod, galvanised

The particularly robust stirring rod for heavy and highly viscous materials, e.g. prefab plasters and mortar, lime, concrete, cement, screed, filling compound, insulating plasters, quartz-filled epoxy resins.

MGV Mortar stirring rod, stainless steel

The stainless steel stirring rod with high durability is particularly suitable for abrasive materials and fodder. Please check

suitability if the material contains acids or caustics!)

LG Glue stirring rod, galvanised

The stirring rod especially for sticky media is particularly suitable for epoxy resin components, concrete coatings, adhesive materials and filling compounds.

RP Mixing paddle, galvanised

The mixing paddle for heavy materials - is suitable for bitumen, clay, thick-film, emulsions and sealing materials. The RP 120 is stainless steel.

right hand spiral (standard):

Stirring rod pulls material from the bottom – few air inclusions, easy guiding, for tough materials

left hand spiral (MG xxx L):

Stirring rod pushes material from the top to the bottom – less splash during mixing for media of low viscosity









Material	S	R	W	M	MGV	LG	RP
Wall paint	x	x					
Emulsion paint	x	x					
Lacquer	x	x					
Zinc dust paint		x					
Mineral paint		x					
Silicate paint	x	x					
Red lead coat	x	x					
Chemicals	x	x			x		
Bitumen		x				x	x
Grouting compounds		x		(x)		x	
Cement laitance	x	(x)		(x)		x	
Plaster/chalk			(x)	x			
Adhesive mortar			x	x			
Ready blended screedmortar			x	x		(x)	
Glue			x	x		x	
Concrete			(x)	x		(x)	
Tile adhesive			x	x		x	
Filling compound			x	x			
Ready mixed filler							
Granules/plaster			x	x	x		
Thermal insulating plaster			(x)	x			x

(X) limited suitability

STIRRING RODS

* left hand spiral *¹ stainless steel - V2A (1.4301; AISI 304) *² protective ring



Stirring rod	type	max. basket diameter	length in mm	batch in kg	shank connection	
S Disc stirring rod	S 55	55	350	5	Ø 7	31501000
	S 80	80	350	15	Ø 7	31502000
	S 100	100	500	40	6- SW 10	31513000
	SG 120	120	590	50	M 14	31524000
	SG 150	150	500	150	M 14	31527000
	SGR 120* ²	120	590	50	M 14	31525000
R Round stirring rod * ²	R 70	70	400	10	6- SW 8	31111000
	R 85	85	400	15	6- SW 8	31112000
	R 100	100	600	20	6- SW 10	31113000
	R 120	120	600	25	6- SW 10	31114000
	RG 100	100	600	20	M 14	31123000
	RG 120	120	600	25	M 14	31124000
W Helicon ribbon stirring rod	W 70	70	400	5	6- SW 8	31211000
	W 85	85	400	8	6- SW 8	31212000
	W 95* ²	95	500	10	6- SW 8	31218000
	W 100	100	600	15	6- SW 10	31213000
	W 120* ²	120	600	20	6- SW 10	31214000
	WG 100* ²	100	600	15	M 14	31223000
	WG 120* ²	120	600	20	M 14	31224000
	WG 135* ²	135	600	50	M 14	31225000
	WG 160* ²	160	600	80	M 14	31227000
	WGV 120* ¹ * ²	120	600	25	M 14	31414000
	M Mortar stirring rod * ²	M 120	120	600	25	6- SW 12
MG 120		120	600	25	M 14	31324000
MG 140		140	600	50	M 14	31326000
MG 160		160	600	80	M 14	31327000
MG 180		180	600	80	M 14	31328000
MG 200		200	600	100	M 14	31329000
MG 120 L*		120	600	25	M 14	31334000
MG 140 L*		140	600	50	M 14	31336000
MG 160 L*		160	600	80	M 14	31337000
MGV Mortar stirring rod * ¹ * ²		MGV 120	120	600	25	M 14
	MGV 140	140	600	50	M 14	31426000
	MGV 160	160	600	80	M 14	31427000
LG Glue stirring rod	LG 120	120	600	25	M 14	31024000
RP Mixing paddle	RP 120* ¹	120	450	25	Ø 10	31434000
	RPG 160	160	600	50	M 14	31437000
  	1) Mixing paddle for Automix 1801					31440000
	2) Special stirring rod for Automix 1801					31442000
	3) Special stirring rod for Automix 90					31460000
	4) Mixing paddle for TwinMix 1800/TwinMix 1800 T					31451000
	5) Scraper for mixing paddle for TwinMix 1800/TwinMix 1800 T					32351000
	6) Universal stirring rod for TwinMix 1800/TwinMix 1800 T					31452000
	7) Special stirring rod for FloorMix 2300					31640000
for Contra twin stirrer (1 pair)						
  	8) Z 200	200	600	40	Special	31620000
	9) Z 220	220	600	60	Special	31610000
	10) Z 230	230	600	80	Special	31630000



Mixing ACCESSORIES

M 14 QUICK CHANGE ADAPTER

For all stirrers with M 14 female thread connection and all stirring rods with M 14 male thread connection

	1 Quick change adapter M 14 with insert	32143000
	2 Insert for quick change adapter M 14 (for stirring rods M 14 male)	32144000
	3 Quick change adapter set M 14 with two inserts	32145000



FEATURES QUICK CHANGE ADAPTER:

- stirring rods can be changed with the plug in quick change adapter, without the need for any tools
- quick change of the mixing tool for different materials
- space saving transport and easy cleaning of the stirring rods
- retrofit for all stirrers M 14 (female) thread
- Operation - screw the clutch of the quick change adapter in the stirrer and plug in the stirring rod, to remove, simply pull back the capsule on the clutch













BUCKET CLAW – THE PRACTICAL HOLDER FOR STIRRING RODS, PAINT BRUSHES, TROWELS AND SCRAPERS

When working with paint, mortar and adhesive there always exists the risk of resulting stains around the workplace. For avoiding this, the special Bucket Claw is offering a clever solution. It is mounted by easy clipping on the bucket rim. Because of its special shape it fits on almost every bucket. From now on coated stirring rods, paint brushes, trowels and scrapers can be fixed on the bucket rim and can drip off easily. In addition the bucket claw can be used as wall holder for your tools.



ADAPTER/EXTENSIONS

We offer the following adapters for the use with stirrers of other brands:

1		6		1	5/8" female - M 14 female		32123000
2		7		2	1/2" female - M 14 female		32113000
3		8		3	M 14 male - 1/2" male		32147000
4		9		4	M 14 female - M 14 female		32153000
5		10		5	M 18 female - M 14 female		32173000
				6	5/8" male - M 14 female		32133000
				7	MT 2 - M 14 female	e.g. heavy duty drilling machines	33113000
				8	MT 3 - M 14 female	e.g. heavy duty drilling machines	33123000
				9	M 14 male - B 18	e.g. chuck	32142000
				10	SDS-plus - M 14 female	e.g. hammer drill	32134000
11				11	Extensions	150 mm x M 14	32230000
						250 mm x M 14	32210000
						400 mm x M 14	32220000

SANDING MILLING SMOOTHING



Model	Page	Disc diameter	Spindle connection	Power input	Rated speed (*No-load speed)
Scabblers and scouring machine EPF 1503 0651I000	 82	140/150 mm	M 14 male	1500 W	4000 rpm
Concrete grinder EBS 120.1 0630F000	 83	125 mm	Ø 22.2 mm	1400 W	*9000 rpm
Concrete grinder EBS 125.4 O/ EBS 125.4 RO 06324000/06325000	 85	125 mm	Ø 22.2 mm	1500 W	10000 rpm/ 6000- 10000 rpm
Concrete grinder EBS 1802/ EBS 1802 SH 0633J000/0633L000	 85	125 mm	Ø 22.2 mm	1800 W	*10000 rpm
Concrete grinder EBS 180 H 0633H000	 86	180 mm	Ø 22.2 mm	2500 W	*8500 rpm
Concrete grinder EBS 180 F 0634H000	 87	180 mm	Ø 22.2 mm	2500 W	*8500 rpm
Concrete grinder EBS 235.1 06347000	 88	235 mm	M 20 male/ Special	2200 W	*1380 rpm
Long reach renovation grinder ELS 125 D 06231000	 89	125 mm	Ø 22.2 mm	1200 W	*8000 rpm
Surface milling machine EOF 100.1 06535000	 92	100 mm	Ø 22.2 mm	1400 W	10000 rpm
Long reach sander ELS 225.1 0620N000	 94	225 mm	velcro	590 W	1050-1600 rpm
Dry-wall sander ETS 225 06203000	 95	225 mm	velcro	700 W	0-1450 rpm
Insulation board sander EWS 400 0620F000	 95	370 mm	Push fit fitting/ velcro	800 W	0-85 rpm
Cordless plaster smoothing machine EPG 400 A 065A1000	 96	370 mm	Push fit fitting/ velcro	18 V, 5,2 Ah Li-Ionen	80 rpm
Plaster smoothing machine EPG 400/EPG 400 WP 06509000/0650L000	 97	370 mm	Push fit fitting/ velcro	500 W	0-60 rpm

Hazardous dust (e. g. silica dust) has to be suctioned by a Dust Class M Vacuum Cleaner!
For our electric power tools we are recommending to use a Vacuum Cleaner of our Eibenstock DSS range!



Cap

impact resistant, robust

Arrangement of motor

vertical – dust is kept away, durable

Speed regulation

adaptation of speed (EBS 125.4 RO)

Dust guard

foldable front edge to get to the edge of the working area

Brush rim

protection against dust emission

Vibration damping

splitting between motor and handle (patented) – efficient vibration absorption, protects the wrists of the user, better grinding performance

Vacuum cleaner connection

Ø 35 mm - suction socket, direct connection of an EIBENSTOCK vacuum cleaner

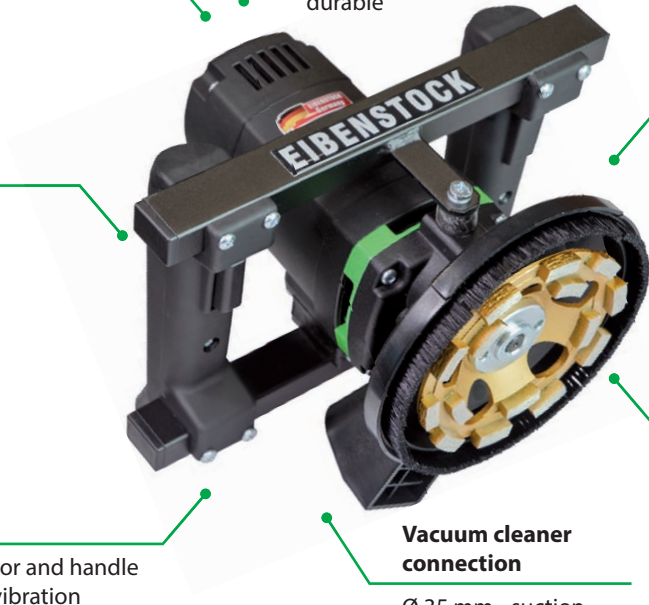

DUST PROTECTION SYSTEM

Mineral dust may cause cancer!

SANDING/MILLING/SMOOTHING

FEATURES OF CONCRETE GRINDERS

The EIBENSTOCK concrete grinder sets the standards in terms of their handiness. The special parallel grip design provides the user with numerous benefits including even distribution of pressure on the disc, even overhead.

The use of a vacuum cleaner with the dusthood ensures a clean working environment, but also prolongs the lifetime of the machine.



**Now available for use with
diamond-grinding wheel Ø 150 mm**



Ø 140

SPECIFICATIONS	EPF 1503
Power input	1500 W
Rated voltage	230 V ~
Rated- /No-load speed	4000 rpm
Milling head diameter	140 mm
Disc diameter	150 mm
Depth adjustment	0.5-4.0 mm
Spindle connection	M 14 male
Weight	3.9 kg
Order no.	06511000
Supplied	in a case incl. capstan with 16 claw cutters (bent)

Diamond-grinding wheel, see page 90

For changing you need:

1x 37416000 tool kit, 1x 76301927 jaw wrench SW 32,
1x 37206000 driving disc, 1x 37207000 driving nut

**Scabbler and scouring machine
EPF 1503**

**The universal with a high
removal rate**

APPLICATION:

- Removal of tile adhesive, plaster, paint, coatings
- Roughing and preparing of surfaces
- Grinding of concrete and screed seams

FEATURES:

- Electronic – soft start, constant speed, speed reduction in case of overload, temperature control and over current cut-off
- Guide ring adjustable – precise depth definition
- Brush rim – high suction power for dust-free working by connecting an industrial vacuum cleaner (accessory) to the 35 mm nozzle
- Soft grip handle – less vibration, non-slip



Depth adjustment: guide ring adjustable – no unintentional immersion in the basic material



Claw cutters bent
for lime-bound plaster



Claw cutters pointed
for cement-bound plaster



Concrete grinder EBS 120.1

The compact

APPLICATION:

- Grinding and smoothing of surfaces
- Removing of screed seams, residual mud, plaster and coatings
- Preparing of surfaces, e.g. for tile renovation
- Working in tight spots for example under radiators and on protrusions
- Concrete, screed, tile adhesive, plaster, paint, coatings, carpet adhesive – with corresponding grinding wheels (accessories)

FEATURES:

- Foldable front edge of dust guard – for grinding directly to the edge of the work area
- Slim housing design – compact, well balanced design
- Soft grip handle – less vibration, non-slip
- Spindle lock – easy tool change



Ø 125

SPECIFICATIONS	EBS 120.1
Power input	1400 W
Rated voltage	230 V ~
No-load speed	9000 rpm
Disc diameter	125 mm
Spindle connection	Ø 22.2 mm
Weight	3.5 kg
Order no.	0630F000
Supplied	in a case incl. diamond-grinding wheel (concrete) and assembly tools





Concrete grinder EBS 125.4 O



Ø 125



Concrete grinder EBS 125.4 RO



Ø 125

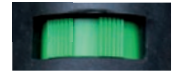

speed regulation

The robust hand-held grinder for small to medium sized surfaces

APPLICATION:

- Grinding and smoothing of surfaces
- Removing of screed seams, residual mud, plaster and coatings
- Preparing of surfaces, e.g. for tile renovation
- Concrete, screed, tile adhesive, plaster, paint, coatings, carpet adhesive, wood* – with corresponding grinding wheels (accessories)

FEATURES:

- Electronic – soft start, constant speed, speed reduction in case of overload, temperature control and over current cut-off
- Speed regulation (EBS 125.4 RO) – allows to work on finishing plaster, lime sand brick and wood with tungsten carbide grit discs
- Foldable front edge of dust guard – for grinding directly to the edge of the work area (no laborious reworking, saves time and costs)
- Brush rim – high suction power for dust-free working by connecting an industrial vacuum cleaner (accessory) to the 35 mm nozzle
- Parallel handle position – ergonomic handles allow exact and balanced guiding for a better surface finish
- Floor guiding device – available as accessory

SPECIFICATIONS	EBS 125.4 O
Power input	1500 W
Rated voltage	230 V ~
Rated- /No-load speed	10000 rpm
Disc diameter	125 mm
Spindle connection	Ø 22.2 mm
Weight	4.7 kg
Order no.	06324000

Supplied

in a case incl. diamond-grinding wheel (concrete) and assembly tools

SPECIFICATIONS	EBS 125.4 RO
Power input	1500 W
Rated voltage	230 V ~
Rated- /No-load speed	6000-10000 rpm
Disc diameter	125 mm
Spindle connection	Ø 22.2 mm
Weight	4.7 kg
Order no.	06325000

Supplied

in a case incl. diamond-grinding wheel (concrete) and assembly tools



Concrete grinder EBS 1802



Ø 125



Concrete grinder EBS 1802 SH



Ø 125



The powerful hand-held grinder for small to medium sized surfaces

APPLICATION:

- Grinding and smoothing of surfaces
- Removing of screed seams, residual mud, plaster and coatings
- Preparing of surfaces, e.g. for tile renovation
- Concrete, screed, tile adhesive, plaster, paint, coatings, carpet adhesive – with corresponding grinding wheels (accessories)
- **EBS 1802 SH – the machine for every surface:** PCD-grinding wheel with monobloc diamonds – high removal rate and long lasting

FEATURES:

- Powerful motor – high capacity
- Electronic – soft start, over current cut-off, overload indication
- Foldable front edge of dust guard – for grinding directly to the edge of the work area (no laborious reworking, saves time and costs)
- Brush rim – high suction power for dust-free working by connecting an industrial vacuum cleaner (accessory) to the 35 mm nozzle
- Parallel handle position – ergonomic handling allows exact and balanced guiding for a better surface finish
- Floor guiding device – available as accessory (not for use with PCD-grinding wheels)

SPECIFICATIONS	EBS 1802
Power input	1800 W
Rated voltage	230 V ~
No-load speed	10000 rpm
Disc diameter	125 mm
Spindle connection	Ø 22.2 mm
Weight	5.9 kg
Order no.	0633J000

Supplied

in a case incl. diamond-grinding wheel (concrete) and assembly tools

SPECIFICATIONS	EBS 1802 SH
Power input	1800 W
Rated voltage	230 V ~
No-load speed	10000 rpm
Disc diameter	125 mm
Spindle connection	Ø 22.2 mm
Weight	5.9 kg
Order no.	0633L000

Supplied

in a case incl. PCD-grinding wheel (pointed segments) and assembly tools

EBS 1802 SH – the machine for every surface: PCD-grinding wheel included in delivery



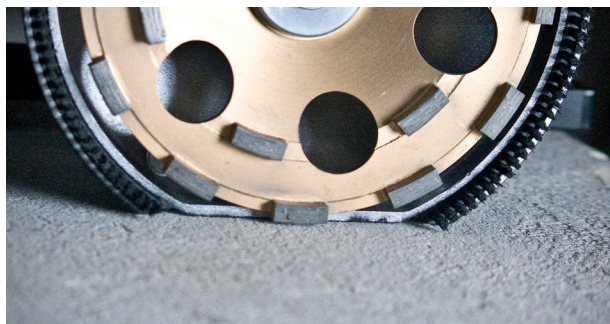

Ø 180

SPECIFICATIONS	EBS 180 H
Power input	2500 W
Rated voltage	230 V ~
No-load speed	8500 rpm
Disc diameter	180 mm
Spindle connection	Ø 22.2 mm
Weight	8.4 kg
Order no.	0633H000
Supplied	in a case incl. diamond-grinding wheel (concrete) and assembly tools

Concrete grinder EBS 180 H

The powerful hand-held grinder for medium sized surfaces

APPLICATION:

- Grinding and smoothing of surfaces
- Removing of screed seams, residual mud, plaster and coatings
- Preparing of surfaces, e.g. for tile renovation
- Concrete, screed, tile adhesive, natural stone, plaster, paint, coatings, carpet adhesive – with corresponding grinding wheels (accessories)

FEATURES:

- Powerful 2500 W motor
- Electronic – soft start, temperature control and over current cut-off
- Foldable front edge of dust guard – for grinding directly to the edge of the work area (no laborious reworking, saves time and costs)
- Brush rim – high suction power for dust-free working by connecting an industrial vacuum cleaner (accessory) to the 35 mm nozzle
- Locking for suction hose – avoids unintentional loosening of the hose during grinding
- Parallel handle position – ergonomic handles allow exact and balanced guiding for a better surface finish

for every surface: PCD-grinding wheel with monobloc diamonds – high removal rate and long lasting (accessory)

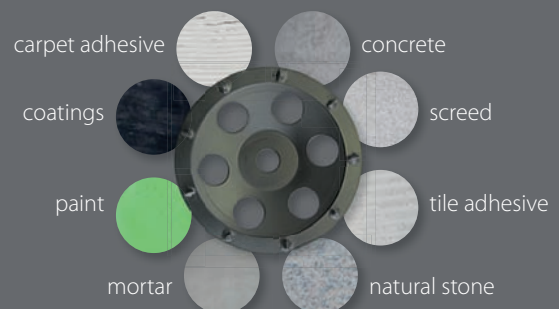

Concrete grinder EBS 180 F

With floor guiding device for medium sized surfaces

APPLICATION:

- Grinding and smoothing of surfaces
- Removing of residual mud, plaster and coatings
- Preparing of surfaces, e.g. for tile renovation
- Concrete, screed, tile adhesive, natural stone, mortar, paint, coatings, carpet adhesive – with corresponding grinding wheels (accessories)

FEATURES:

- Powerful 2500 W motor
- Electronic – soft start, temperature control and over current cut-off
- Segment on the dust-guard detachable – for grinding directly to the edge of the work area (no laborious reworking, saves time and costs)
- Brush rim – high suction power for dust-free working by connecting an industrial vacuum cleaner (accessory) to the 35 mm nozzle
- Tilt-adjustable floor guiding device and additional handle adjustable in height – optimal adjustment to the body height of the operator for a comfortable guiding

for every surface: PCD-grinding wheel with monobloc diamonds – high removal rate and long lasting (accessory)

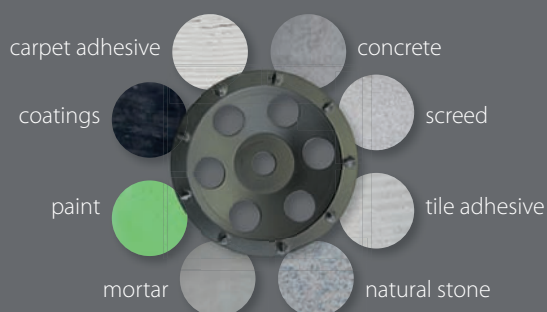

**Relaxed working
in upright posture**

**Carriage adjustable
in height –
better grinding result**



Ø 180

SPECIFICATIONS	EBS 180 F
Power input	2500 W
Rated voltage	230 V ~
No-load speed	8500 rpm
Disc diameter	180 mm
Spindle connection	Ø 22.2 mm
Weight	10.5 kg
Order no.	0634H000

Supplied in a box incl. diamond-grinding wheel (concrete) and assembly tools





Ø 235

SPECIFICATIONS	EBS 235.1
Power input	2200 W
Rated voltage	230 V ~
No-load speed	1380 rpm
Disc diameter	235 mm
Spindle connection	M 20 male/Special
Weight	38 kg
Order no.	06347000
Supplied	in a box incl. base plate for diamond-grinding shoe set

Choose and order also the appropriate grinding shoes for your application (see accessories pages 90/91)!

Concrete grinder EBS 235.1

The powerful floor grinder for large surfaces

APPLICATION:

- Grinding and smoothing of large surfaces
- Removing of coatings
- Preparing of surfaces, e.g. for carpet renovation in living rooms and cellars, garages and on balconies
- Concrete, screed, tile adhesive, natural stone, paint, coatings, carpet adhesive – with corresponding grinding wheels/-shoes (accessories)

FEATURES:

- 2200 Watt single-phase AC-motor – durable, high load capacity, easy to service
- Segment on the dust-guard detachable and adjustable handle – for grinding directly to the edge of the work area (no laborious reworking, saves time and costs)
- Brush rim – high suction power for dust-free working by connecting an industrial vacuum cleaner (accessory) to the 35 mm nozzle
- Carriage adjustable in height – better grinding result
- Tilt-adjustable floor guiding device – optimal adjustment to the body height of the operator for a comfortable guiding
- Low weight and additional handle on the motor – easy transport

base plate for use with interchangeable segments (accessory)



Long reach renovation grinder ELS 125 D

For wall and ceiling

APPLICATION:

- Grinding of screed seams
- Removing of burrs, bumps, paint and thin adhesives
- Smoothing of concrete and plaster surfaces

FEATURES:

- Electronic – soft start, constant speed, temperature control and over current cut-off
- Exchangeable flexible drive shaft – short design, easy to service
- Robust joint – optimal adaptation to inclination and angle
- Foldable front edge of dust guard – for grinding directly to the edge of the work area
- Extraction nozzle Ø 35 mm (rotatable) - direct connection of an M-cleaner of the EIBENSTOCK DSS series
- Locking for suction hose – avoids unintentional loosening of the hose during grinding
- Additional handle – ergonomic handling, variably adjustable at the machine



SPECIFICATIONS	EFW
Working height	max. 2600 mm
Working height with 1x Extension	max. 2900 mm
Order no.	3765A000
Supplied	in a box
Accessories	Extension
Working height	300 mm
Order no.	3765B000



drive shaft

can be changed easily, quickly and inexpensively by the user without opening the machine

Ø 125

DUST PROTECTION SYSTEM

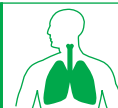

Mineral dust may cause cancer!

SPECIFICATIONS	ELS 125 D
Power input	1200 W
Rated voltage	230 V ~
Rated- /No-load speed	8000 rpm
Disc diameter	125 mm
Spindle connection	Ø 22.2 mm
Weight	5.3 kg
Order no.	06231000
Supplied	in a box incl. transport bag, diamond-grinding wheel universal and assembly tools

Cart EFW for Long reach renovation grinder ELS 125 D

- Mobile cart for Machine and vacuum cleaner
- Force saving in ceiling work
- Toolless design - easy transport, rubberized steering wheels-easy moving, one wheel braked





A Sanding/Milling ACCESSORIES

		concrete	screed	tile adhesive	natural stone
EPF 1503		1	1	1/2	
EBS 120.1		4/5	6	6	
EBS 125.4 O EBS 125.4 RO		4/5	6	6	
EBS 1802 EBS 1802 SH		4/5/9	6/9	6/9	9
EBS 180 H EBS 180 F		10/11	11/12	11/12	12
EBS 235.1		13/14/15	14*/16	14*/16	14
ELS 125 D		17/18		18	

*limited suitability

1	Diamond-grinding wheel Ø 150 mm	37127000
	Claw cutters	
2	bent, 16 pieces	37426000
3	pointed, 16 pieces	37427000
	Diamond-grinding wheel Ø 125 mm	
4	concrete standard	37114000
5	concrete premium	37102000
6	screed	37103000
7	coatings „Rapid K“	37110000
8	Tungsten carbide grit disc Ø 125 mm for EBS 125.4 RO	
	rough	37107000
	medium	37106000
	fine	37108000
9	PCD-grinding wheel Ø 125 mm	
	pointed segments	37115000
	round segments	37118000
	Diamond-grinding wheel Ø 180 mm	
10	concrete	37112000
11	screed	37111000

12	PCD-grinding wheel Ø 175 mm round segments	37119000
13	Diamond-grinding wheel Ø 235 mm concrete	37117000
14	PCD-grinding shoe set, 5 parts with support segment, round segments	37121000
	Diamond-grinding shoe set, 5 parts	
15	concrete	37122000
16	screed	37123000
	Diamond-grinding wheel Ø 125 mm	
17	surface grinding	37126000
18	universal	37128000

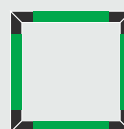

suitable for sanding directly to the edge of the work area



suitable for illustrated surface conditions



**Time- and material saving
compared to alternative methods
⇒ easy and economical working**



no hazardous,
chemical substances



no unhealthy,
persistent odors



no clogging of
abrasives

Ø 100



SPECIFICATIONS

EOF 100.1

Power input	1400 W
Rated voltage	230 V ~
Rated- /No-load speed	10000 rpm
Milling depth	0.1-1.0 mm
Disc diameter	100 mm
Spindle connection	Ø 22.2 mm
Weight	3.4 kg
Order no.	06535000
Supplied	in a case incl. assembly tools, without milling disc

**Choose and order also the appropriate milling discs for
your application (see accessories page 98)!**

Surface milling machine EOF 100.1

The innovative surface milling system as precise and fast alternative – high power but low weight

APPLICATION:

- Fine milling of paint, varnish, resins, solid and greasy dirt as well as coatings on plane wood and mineral surfaces
- Used for renovation and reconstruction up to restoration

FEATURES:

- Precision hood – depth adjustment in 0.1 mm steps for exact removing (up to max. 1.0 mm) – no unintentional milling in the basic material
- Turnable dust guard – flexible adaptation to the surface to be machined especially to the edges
- Support bow – precise guiding, no tilting of the machine
- Compact, slim design – handy
- Soft grip handle – less vibration, non-slip, perfect handling
- Powerful 1400 W motor
- Electronic – soft start, constant speed, Restart protection – perfect working results, protection of the machine
- Lock-on button – against unintentional switching on
- Spindle lock – easy tool change



depth adjustment
(0.1 - 1.0 mm)



a detent point corresponds
to a depth of 0.1 mm



Turnable dust guard
Ø 35 mm

WITH TUNGSTEN CARBIDE PRECISE AND QUICK ON WOOD SURFACES



e.g. gates, doors, stairs, balconies and facade claddings

SANDING/MILLING/SMOOTHING

WITH PCD PRECISE AND QUICK ON MINERAL SURFACES



PCD milling disc
 pointed segments: for slightly rough surfaces
 round segments: for smooth surfaces

e.g. thin decorative plasters, markings, coatings and paints



**Only about 1.5 kg
perceived weight**

only in conjunction with
EIBENSTOCK
industrial vacuum cleaner
DSS 25 M



Ø 225



**DUST
PROTECTION
SYSTEM**

Mineral dust may cause cancer!

SPECIFICATIONS

ELS 225.1

Power input	590 W
Rated voltage	230 V ~
No-load speed	900-1800 rpm
Disc diameter	225 mm
Spindle connection	M 14 (velcro)
Weight	4.9 kg

Order no. 0620N000

Supplied in a box incl. transport bag,
extension, sanding pad starter
kit (1x P80/P100/P120) and
brush rim

Long reach sander ELS 225.1

The lightweight for large surface performance with patented VacuGlide-System for relaxed working

APPLICATION:

- Effort- and time-saving sanding of walls and ceilings for the dry-wall construction
- Sanding of filling compounds
- Sanding works during renovating and painting works, for example the removing of wallpaper residues
- Sanding of heat insulation panels

FEATURES:

- Electronic – soft start, electronic overload protection
- Exchangeable flexible drive shaft
- Robust joint for optimum adaptation to inclination angle
- Spring-mounted exhaust hood with sealing lip – optimal adaptation to the surface
- Efficient dust extraction through the hood and perforated sanding disc
- Sealing lip exchangeable against brush rim for other sanding operations
- Extension for high ceilings and walls (up to about 3 m) – no additional tools such as ladder or scaffolding, saves time in the application
- Lightweight, balanced and ergonomic design – easy to use, comfortable sanding, numerous grip positions



Cart EFW for Long reach sander ELS 225.1

- Mobile cart for Machine and vacuum cleaner
- Force saving in ceiling work
- Toolless design - easy transport, rubberized steering wheels-easy moving, one wheel braked

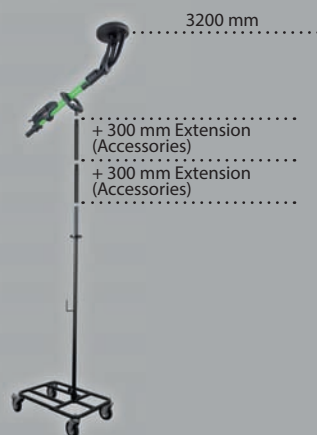

SPECIFICATIONS	EFW
Working height	max. 2600 mm
Working height with 2x Extension	max. 3200 mm
Order no.	3765A000
Supplied	in a box
Accessories	Extension
Working height	300 mm
Order no.	3765B000

» Dry-wall sander ETS 225



Ø 225



» Insulation board sander EWS 400



Ø 370



The lightweight and handy specialist for drywall construction

APPLICATION:

- Sanding operations for the dry-wall construction
- Working on wood and metal surfaces
- Ideal in tight places and small rooms
- Sanding of plaster, filler, paint

FEATURES:

- Electronic switch – stepless speed control
- Large sanding disc, high speed – high removal efficiency
- Motor above sanding disc in a dust free zone – longer lifetime
- Special dust hood with detachable segment – sanding to the edge of the surface
- Dust extraction with brush rim and punched sanding disc – direct connection to vacuum cleaner

The insulation board sander for large surfaces

APPLICATION:

- Sanding of foamed polystyrene and mineral insulation panels for heat insulations

FEATURES:

- Electronic switch – stepless speed control
- Triple special gearbox – high torque, powerful, durable
- Dust extraction by hood with brush rim and perforated sanding disc – emission of sanding dust and particles is effectively removed, saves time-consuming cleaning of the construction site
- Dust extraction – direct connection for industrial vacuum cleaner
- Flexible hood – gets close to the surface
- Large tool surface – smoothly and quick working

SPECIFICATIONS	ETS 225
Power input	700 W
Rated voltage	230 V~
Rated speed	0-1450 rpm
No-load speed	0-2300 rpm
Disc diameter	225 mm
Spindle connection	velcro
Weight	2.9 kg
Order no.	06203000

Supplied in a case incl. base plate and sandpaper-starter kit (1x P60/P80/P100/P220)

SPECIFICATIONS	EWS 400
Power input	800 W
Rated voltage	230 V~
Rated speed	0-85 rpm
No-load speed	0-140 rpm
Disc diameter	370 mm
Spindle connection	Push fit fitting/velcro
Weight	3.9 kg
Order no.	0620F000

Supplied in a box incl. 1x sandpaper P24





When using the CAS-System already you may order without charger and batteries



Ø370



SPECIFICATIONS	EPG 400 A
Battery pack	18 V, 5.2 Ah Li-Ion
No-load speed	80 rpm
Diameter base plate	370 mm
Spindle connection	Push fit fitting/velcro
Weight	3.8 kg (machine) 670 g (battery)
Order no.	065A1000

in a case incl. base plate and sponge disc, battery charger (standard), 2x battery 5.2 Ah

Order no. 065A2000

without a charger and batteries in a case
incl. base plate and sponge disc

ALSO AVAILABLE
WITHOUT A BATTERY



Cordless plaster smoothing machine EPG 400 A

The cordless freedom

APPLICATION:

- Smoothing, scraping and structuring of plaster
- Sanding of panels for heat insulations
- Smoothing and cleaning of surfaces

FEATURES:

- No more cumbersome cables - freedom of movement especially on the scaffolding
- Approx. 30 minutes with one battery charge
- Large tool surface - smooth and quick working



NOW ALSO WITH
BATTERY



Plaster smoothing machine EPG 400



Ø 370

Plaster smoothing machine EPG 400 WP



Ø 370

saves at least
50% time

The light and versatile plaster smoothing machine

APPLICATION:

- Smoothing, scraping and structuring of plaster
- Sanding of panels for heat insulations
- Smoothing and cleaning of surfaces

FEATURES:

- Electronic switch – stepless speed control
- Triple special gearbox – high torque, powerful, durable
- Large tool surface – smooth and quick working
- Low weight – for effortless work
- Large handles – balanced, ergonomic design, convenient working

Plaster smoothing machine with water supply

APPLICATION:

- Smoothing, scraping and structuring of plaster
- Sanding of panels for heat insulations
- Smoothing and cleaning of surfaces

FEATURES:

- Electronic switch – stepless speed control
- Stepless adjustable water supply – direct moistening of the wall by means of an atomised spray, saves adding water separately, thus time saving
- Triple special gearbox – high torque, powerful, durable
- Large tool surface – smooth and quick working
- Low weight – for effortless work
- Large handles – balanced, ergonomic design, convenient working

SPECIFICATIONS	EPG 400
Power input	500 W
Rated voltage	230 V ~
Rated speed	0-60 rpm
No-load speed	0-110 rpm
Diameter base plate	370 mm
Spindle connection	Push fit fitting/velcro
Weight	3.5 kg
Order no.	06509000

Supplied

in a case incl. base plate
and sponge disc

SPECIFICATIONS	EPG 400 WP
Power input	500 W
Rated voltage	230 V ~
Rated speed	0-60 rpm
No-load speed	0-110 rpm
Diameter base plate	370 mm
Spindle connection	Push fit fitting/velcro
Weight	3.8 kg
Order no.	0650L000

Supplied

in a case incl. base plate
and sponge disc





A Sanding/Milling/Smoothing ACCESSORIES

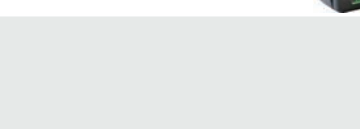
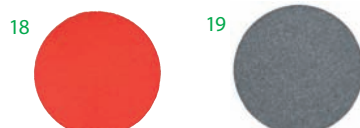
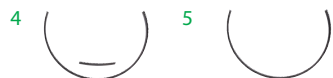

FOR SURFACE MILLING MACHINE

1	Carbide milling disc for wood surfaces	37124000
2	PCD milling disc for mineral surfaces (round segments)	37125000
3	PCD milling disc for mineral surfaces (pointed segments)	37116000

FOR LONG REACH SANDER AND DRY-WALL SANDER

	Brush rim	
4	ETS 225, 2 parts	37624000
5	ELS 225.1	3722B000
6	Sealing lip VacuGlide ELS 225.1	3722C000
7	Segment incl. brush for dust guard ETS 225	37625000
8	Additional handle ELS 225/ELS 225.1	37659000
9	Base plate (velcro), 6 hole punch	37631000
10	Rubber foam pad (velcro), 6 hole punch	37632000
11	Sanding grid (velcro), 6 hole punch	
	P80 (10 pieces)	37610000
	P120 (10 pieces)	37611000
12	Sandpaper (velcro), 6 hole punch	
	P24 Semi-friable Corundum (10 pieces)	37608000
	P40 Normal Corundum (25 pieces)	37642000
	P60 Normal Corundum (25 pieces)	37643000
	P80 Normal Corundum (25 pieces)	37644000
	P100 Normal Corundum (25 pieces)	37645000
	P120 Normal Corundum (25 pieces)	37646000
	P150 Normal Corundum (25 pieces)	37647000
	P180 Normal Corundum (25 pieces)	37648000
	P220 Normal Corundum (25 pieces)	37649000
13	Sandpaper Assortment (velcro), 6 hole punch	37640000
	P80/100/120/150/180 Normal Corundum (je 5 pieces)	
14	Sanding pad (velcro), perforated	
	P40 (10 pieces)	37672000
	P60 (10 pieces)	37673000
	P80 (10 pieces)	37674000
	P100 (10 pieces)	37675000
	P120 (10 pieces)	37676000
	P150 (10 pieces)	37677000
	P180 (10 pieces)	37678000
	P220 (10 pieces)	37679000

FOR INSULATION BOARD SANDER

15	Sandpaper (velcro), 4 hole punch P24 (3 pieces)	37671000
----	--	----------

FOR PLASTER SMOOTHING MACHINES

16	Base plate Ø 370 mm	37721000
17	Sponge disc Ø 400 mm (velcro)	37722000
18	Sponge rubber disc Ø 385 mm (velcro)	37725000
19	Felt disc Ø 395 mm	37729000
20	Scraping disc Ø 380 mm (velcro)	37726000
21	Scratch- and scraping disc Ø 380 mm (velcro)	3772A000
22	Add on kit for scratch- and scraping disc (4 scratching metal sheets+8 screws)	3772B000
23	Scratching disc Ø 370 mm	37724000
24	Add on kit for scratching disc (4 scratching metal sheets+8 screws)	37723000
25	Smoothing disc Ø 380 mm	37728000
26	Sanding disc P24, Ø 370 mm (velcro)	37727000
27	Quick charger (charging time about 45 min.)	37732000
28	Charger standard (charging time about 110 min.)	37734000
29	Battery (5,2 Ah)	37731000

SAWING CUTTING SLITTING





Model		Page	Disc diameter	Spindle connection	Power input	Rated speed (*No-load speed)
Diamond saw EDS 125 0660V000		101	125 mm	Ø 22.2 mm	1250 W	*12000 rpm
Cutting tables ETT 700 09801000 ETT 1200 09802000		103				
Diamond saw EDS 181 0660P000		104	180 mm	Ø 22.2 mm	2300 W	4300 rpm
NEW Universal cutting saw EST 350.2 06637000		106	350 mm	Ø 25.4 mm	2400 W	*3900 rpm
Cutting system ETR 230 06812000		107	230 mm	Ø 22.2 mm	2600 W	*6500 rpm
Cutting system ETR 350.1 P 0681A000		108	350 mm	Ø 25.4 mm	2700 W	2200 rpm
Cutting system ETR 400.1 P 0682A000		108	400 mm	Ø 25.4 mm	2700 W	1950 rpm
Double blade sword saw EDB 480.1 06644000		110	Cutting length 480 mm	Special	1800 W	Stroke rate 3100
Wall chaser EMF 125.2 06703000		110	125 mm	Ø 22.2 mm	1.700 W	7.500 min ⁻¹
Wall chaser EMF 150.1 0671A000		113	150 mm	Ø 22.2 mm	2300 W	4300 rpm
NEW Wall chaser EMF 180.2 0672C000		114	180 mm	Ø 22.2 mm	2300 W	2200 rpm

Hazardous dust (e. g. silica dust) has to be suctioned by a Dust Class M Vacuum Cleaner!
For our electric power tools we are recommending to use a Vacuum Cleaner of our Eibenstock DSS range!

Diamond saw EDS 125

The handy diamond saw

APPLICATION:

- Wet and dry cutting of different stones, e.g. natural stone, stoneware
- Cutting of tiles and plates
- Joint milling
- Curved cuts (with corresponding diamond blades)
- Tilers and pavers

FEATURES:

- Mitre adjustment (stepless up to 45°) and cutting depth adjustment (stepless up to 36 mm) without the need for tools
- Immersion function – you can begin the cut with the machine in the working area
- Roller guided plate – smooth guiding, protects the surface
- Integrated water supply with flow regulator – easy adjustment of the water-volume and dust free working while wet cutting
- Nozzle diameter 35 mm – direct connection of industrial vacuum cleaner of EIBENSTOCK DSS series
- Guide rail – accessory for precise cuts



SPECIFICATIONS	EDS 125
Power input	1250 W
Rated voltage	230 V ~
No-load speed	12000 rpm
Max. disc diameter	125 mm
Max. cutting depth	36 mm
Spindle connection	Ø 22.2 mm
Weight	2.9 kg
Order no.	0660V000
Supplied	in a case incl. diamond cutting disc Ø 125 mm and assembly tools



THE FEATURES OF THE DIAMOND SAW EDS 125



Mitre adjustment without the need for tools
– stepless up to 45°



Continuous cutting depth adjustment
without the need for tools – stepless up to
36 mm



Roller guided plate – smooth guiding,
protects the surface

Guide rail – accessory for precise cuts



Nozzle diameter 35 mm – direct connection
of industrial vacuum cleaner of EIBENSTOCK
DSS series

Integrated water supply with flow regulator
– easy adjustment of the water-volume and
dust free working while wet cutting

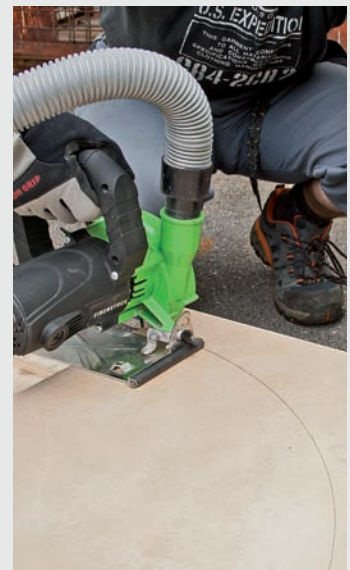

Cutting tables for EDS 125 ETT 700 and ETT 1200

The flexible alternative to unwieldy cutting machines

APPLICATION:

- Wet and dry cutting of different stones, e.g. natural stone, stoneware, ceramics
- Precisely cutting of tiles and plates up to a thickness of 20 mm
- Tilers and pavers



ADVANTAGES PRIMARILY IN DRY CUTTING: TIME AND COST SAVINGS

- use directly at the site
- drying time of the tile is eliminated – can be laid directly
- dirty water doesn't have to be recycled

FEATURES:

- Aluminium/stainless steel-combination – rust-proof
- Low weight, handy – easy to transport by one person
- Fast, fixing of the saw without any tool in the precisely bearing carriage
- Non-slip covering – fixing of the tile during the cut, reduces vibrations
- Adjustable side stop for serial cutting
- Adjustable angular stop for diagonal cuts up to 45°
- Plate enlargement – solid, unbreakable support for particularly large plates, on both sides in all positions mountable and arbitrarily expandable (accessory)

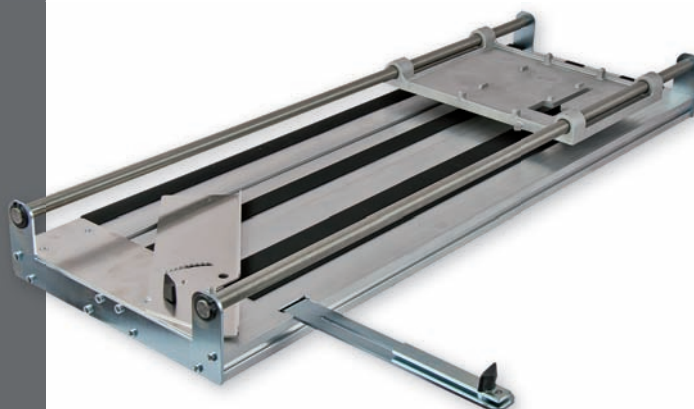
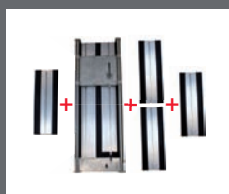

fixing of the saw without any tool



easy to transport



SPECIFICATIONS	ETT 700	ETT 1200
Max. cutting length	700 mm	1200 mm
Weight	14.5 kg	18.0 kg
Order no.	09801000	09802000

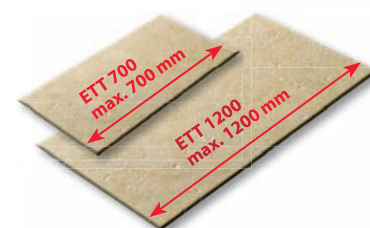



Ø 200



SPECIFICATIONS

EDS 181

Power input	2300 W
Rated voltage	230 V ~
Rated speed	4300 rpm
No-load speed	7500 rpm
Max. disc diameter	200 mm
Max. cutting depth	63 mm*
Spindle connection	Ø 22.2 mm
Weight	7.7 kg

Order no. 0660P000

Supplied in a case incl. diamond cutting disc Ø 180 mm, angle stop and assembly tools

Diamond saw EDS 181

The most powerful in its class

APPLICATION:

- Wet and dry cutting of different stones, e.g. granite, marble, concrete, terrazzo, stoneware
- Cutting of tiles, window sills, terrace slabs, worktops, facing stones, stones used in gardening and landscaping
- For cutting out openings in kitchen worktops
- Joint milling
- Tilers and pavers, gardening and landscaping, kitchen installer, stonemasonry, floor renovator

FEATURES:

- Electronic – soft start, temperature control and over current cut-off, overload indication
- High-performance gearbox and powerful 2300 W motor – fast working even through the hardest stone
- ON/OFF switch with lock – no unintentional switching on
- Mitre adjustment (stepless up to 45°) and cutting depth adjustment (stepless up to 63 mm) without the need for tools
- Immersion function and depth limiting – precise cuts, you can begin the cut with the machine in the working area
- Roller guided plate – smooth guiding, protects the surface
- Easy change between dry and wet cutting – by means of a direct diameter 35 mm connection to the vacuum cleaner or the enclosed Gardena-quick coupling adapter on the 35 mm connection hose
- Locking for suction hose – avoids unintentional loosening of the hose during cutting
- Spindle lock – easy tool change
- Guide rail – accessory for precise cuts

* without guide rail with diamond cutting disc Ø 200 mm



THE FEATURES OF THE DIAMOND SAW EDS 181



Mitre adjustment without the need for tools
– stepless up to 45°



Continuous cutting depth adjustment
without the need for tools – stepless up to
63 mm



Roller guided plate – smooth guiding,
protects the surface

Guide rail – accessory for precise cuts



Nozzle diameter 35 mm – direct connection
of industrial vacuum cleaner of EIBENSTOCK
DSS series or to the enclosed Gardena-quick
coupling adapter





NEW



Ø 350

Order diamond cutting disc Universal at the same time (Accessories see page 115)



SPECIFICATIONS

EST 350.2

Power input	2400 W
Rated voltage	230 V~
No-load speed	3900 rpm
Max. disc diameter	350 mm
Max. cutting depth	120 mm
Max. cutting length	250 mm
Spindle connection	Ø 25.4 mm
Weight	19 kg

Order no. 06637000

Supplied

in a box incl. diamond cutting disc Ø 350 mm and assembly tools

Universal cutting saw EST 350.2

The precise and dust free machine for dry cutting

APPLICATION:

- Cutting of stone materials, e.g. concrete, natural stone, bricks
- Ideal for precise cuts on pavements work
- cutting of steel, plastic and similar materials with new universal cutting blade (accessory)
- Gardening and landscaping, road and pavement construction, for clinker-cutting etc.

FEATURES:

- New ergonomic handle - comfortable operation from all working positions
- Cutting table made of cast aluminum - robust and durable
- Optimized dust collection due to closed base at the machine table
- Tool-less adjustable quick clamping device - safe fixing to the work area
- Spindle lock - easy tool change
- Angular stop stepless adjustable 0-45° - easy and precise mitre cuts
- Starting current limiter - soft start
- Nozzle diameter 35 mm - direct connection of industrial vacuum cleaner of EIBENSTOCK DSS series
- Transportation lock in hinged position - handy and safe transport of the machine

Cutting table (cutting capacity at 90° cuts)

Cutting depth: 80 mm 100 mm 120 mm

Cutting length: 250 mm 200 mm 150 mm



adjustable angle stop

quick clamping device



Cutting system ETR 230

The flexible system for dust free cutting

APPLICATION:

- Cutting of mineral plates, roof tiles, concrete curbs and natural stone plates
- Breakthroughs into brickwork
- Slitting of expansion joints
- Working on concrete stones
- Cutting of metal
- Gardening and landscaping, civil construction, roofers

FEATURES:

- Powerful but light machine
- Electronic – soft start
- Cut-off carbon brushes – protection of the motor
- Immersion function – adjustable cutting depth without the need for tools
- Robust dust guard made of metal
- Protection guard for cutting metal adjustable 360° without the need for tools
- Spindle lock – easy tool change
- Vibration damped handle – mountable in different positions
- Lock-on button with protection against unintentional switching on
- Nozzle diameter 35 mm – direct connection of industrial vacuum cleaner of EIBENSTOCK DSS series



cutting depth adjustment

exhaust



Ø 230

SPECIFICATIONS	ETR 230
Power input	2600 W
Rated voltage	230 V ~
No-load speed	6500 rpm
Max. disc diameter	230 mm
Max. cutting depth	65 mm
Spindle connection	Ø 22.2 mm
Weight	7.5 kg
Order no.	06812000
Supplied	in a case incl. diamond cutting disc Ø 230 mm, dust guard, protection guard and assembly tools



DUST PROTECTION SYSTEM

Mineral dust may cause cancer!

SAWING/CUTTING/SPLITTING



Optimized & strong special motor with power electronics

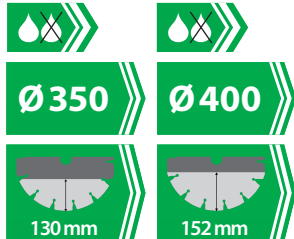

SPECIFICATIONS	ETR 350.1 P	ETR 400.1 P
Power input	2700 W	2850 W
Rated voltage	230 V ~	230 V ~
Rated- /No-load speed	2200 rpm	1950 rpm
Max. disc diameter	350 mm	400 mm
Max. cutting depth	130 mm	152 mm
Spindle connection	Ø 25.4 mm	Ø 25.4 mm
Weight	12.9 kg	13,4 kg
Order no.	0681A000	0682A000

Supplied

in a box incl. diamond cutting disc, dust guard and assembly tools



Integrated water supply with flow regulator

easy adjustment of the water-volume
low dust working



Dry cut for refurbishment

where no wet cut is possible-e.g. Living room renovation



DUST PROTECTION SYSTEM

Mineral dust may cause cancer!

Special developed suction system for dust reduced working

Powerful cutting systems ETR 350.1 P / ETR 400.1 P (wet/dry)

APPLICATION:

- Cutting of mineral materials, f. e. concrete, brick and natural stone
- Cut-outs into brickwork
- Wall cuttings for installations
- Slitting of expansion joints
- Civil engineering, drilling and sawing contractors, gardening and landscaping

Simple, safe guidance through innovative drive concept

- ➔ no kick-back
- ➔ pulls into the material



FEATURES:

- Special gearbox with optimal adjusted speed for fast working
- Electronic – soft start, constant speed, temperature control and over current cut-off, overload indication
- Best results in system with the EE premium diamond cutting disc
- Immersion function
- Adjustable cutting depth limitation without any tools f. e. for the cutting of screed (accessory)
- Adapter and diamond cutting disc for working near to the edge (accessory)
- Exact wall cuttings by using a guide rail (accessory) – easy mounting, easy feed, low vibration
- Wide supporting rolls – exact guiding
- Spindle lock – easy tool change
- Robust metal suction hood
- Handle and hood adjustable – ergonomic handling in different working positions
- Nozzle diameter 35 mm – direct connection of industrial vacuum cleaner of EIBENSTOCK DSS series
- Cut-off carbon brushes – protection of the motor



precise cutting depth adjustment (accessory)



cutting near to the edge (accessory)

SYSTEM OF GUIDE RAILS AS ACCESSORY

**Safe, precise and energy-saving -
System of Guide rails with crank feed
for relaxed working**

**Quick mounting
Easy transport by only person
Robust carriage mounted on roller
bearings - easy feed**

**Easy modular possibility of extension
for long straight cuts**

**Fast mounting of the machine
without any tools**

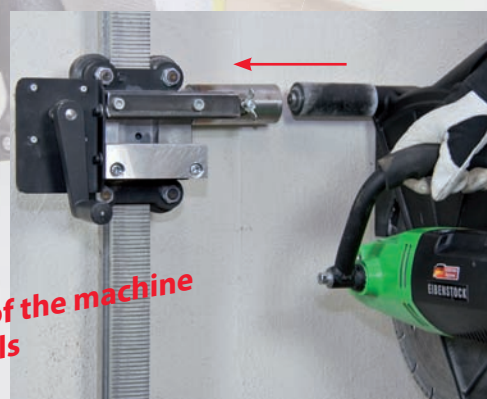



480



SPECIFICATIONS

EDB 480.1

Power input	1800 W
Rated voltage	230 V ~
Stroke rate	3100 rpm
Cutting length	480 mm
Spindle connection	Special
Weight	6.1 kg
Order no.	06644000
Supplied	in a box incl. blade set universal Premium, blade protection and assembly tools

Double blade sword saw EDB 480.1

The powerful all-rounder for various building materials

APPLICATION:

- Cutting of vertical coring brick (f.e. Poroton®), aerated concrete, wood and pressure-resistant insulation material
- Flexible, fast and hence cost saving cutting of vertical coring brick compared to heavy transportable brick saws
- Easy realization of notches as well as exact cuttings
- Construction and civil engineering, drywall, carpentry

FEATURES:

- Robust design with durable, powerful 1800 W motor for hardest applications – high cutting speed, diagonal cuts in vertical coring brick possible w/o problems
- Robust warp resistant sword for precise cutting
- Two counter-saw blades – blow-back proof sawing
- Blower function – dust protection for gearbox and user
- Ergonomic handle – mountable on two sides
- Compact and slim design – easy to handle, working close to edges
- Easy change of saw blades

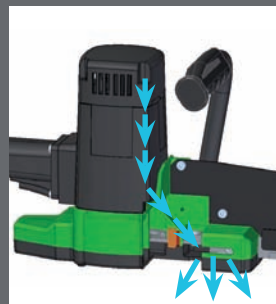

blower function

handle mountable
on both sides



SAWING/CUTTING/SPLITTING



**The lightweight
in its power
class**

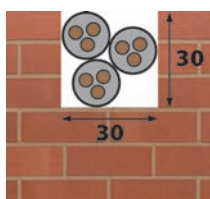

slitting of cable channels

Ø 125

SPECIFICATIONS

EMF 125.2

Power input	1700 W
Rated voltage	230 V ~
Rated- /No-load speed	7500 rpm
Disc diameter	125 mm
Spindle connection	Ø 22.2 mm
Max. milling depth	30 mm
Max. slot width	30 mm
Weight	3.5 kg

Order no. 06703000

Supplied in a case incl. 2 diamond blades Premium and assembly tools

Wall chaser EMF 125.2

Handy and lightweight – perfect for electrical installations

APPLICATION:

- Milling of slots and ducts in sand-lime brick and brickwork
- Electrical installations

FEATURES:

- Electronic – soft start, constant speed
- Cut-off carbon brushes – protection of the motor
- Locking for suction hose – avoids unintentional loosening of the hose during milling
- Adjustable milling depth – without the need for a tool
- Spindle lock – easy tool change
- Slim design, small distance between dust hood and diamond blades for working up to 10 mm from the edge
- Slot widths of 7-30 mm adjustable in 1 mm steps
- Closed hood – optimal air flow, easy removal of fragments
- Pushing cut – allows a comfortable handling
- Nozzle diameter 35 mm – direct connection of industrial vacuum cleaner of EIBENSTOCK DSS series



locking for suction hose



milling depth adjustment



Wall chaser EMF 150.1

The powerful wall chaser for the hardest materials

APPLICATION:

- Milling of slots and ducts in concrete, sand-lime brick, brickwork
- Electrical installations, sanitary, heating and ventilation construction

FEATURES:

- Powerful 2300 W motor
- Electronic – soft start, temperature control and over current cut-off, overload indication
- Parallel handle position – comfortable working position
- Locking for suction hose – avoids unintentional loosening of the hose during milling
- Adjustable milling depth – without the need for a tool
- Spindle lock – easy tool change
- Slim design, small distance between dust hood and diamond blades for working up to 18 mm from the edge
- Slot widths of 7-46 mm adjustable in 1 mm steps
- Closed hood – optimal air flow, easy removal of fragments
- Pushing cut – allows a comfortable handling
- Nozzle diameter 35 mm – direct connection of industrial vacuum cleaner of EIBENSTOCK DSS series

Comparison: preparing an open channel of 46 mm width



EIBENSTOCK „Easy Break Out“ – fast breaking by a center slot

Distance discs for the using of 3 blades (see accessories page 116)

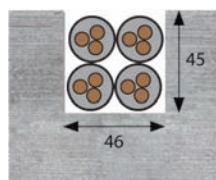

slitting of cable channels

Ø 150

SPECIFICATIONS	EMF 150.1
Power input	2300 W
Rated voltage	230 V ~
Rated speed	4300 rpm
No-load speed	7500 rpm
Disc diameter	150 mm
Spindle connection	Ø 22.2 mm
Max. milling depth	45 mm
Max. slot width	46 mm
Weight	6.1 kg
Order no.	0671A000
Supplied	in a case incl. 2 diamond blades Premium (concrete) and assembly tools



SAWING/CUTTING/SPLITTING



Almost dust-free immersion and slitting due to folding hood

NEW

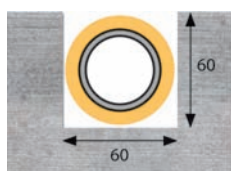

slitting of channels



Ø 180

Now with 60 mm slot width for effective work in the sanitary installation

Split work spindle - possibility of milling discs up to 10 mm segment thickness



SPECIFICATIONS

	EMF 180.2
Power input	2300 W
Rated voltage	230 V ~
Rated speed	2200 rpm
No-load speed	3100 rpm
Disc diameter	180 mm
Spindle connection	Ø 22.2 mm
Max. milling depth	60 mm
Max. slot width	60 mm
Weight	8.2 kg

Order no. 0672C000

Supplied

in a case incl. 2 diamond blades Premium (concrete) and assembly tools

Wall chaser EMF 180.2

The powerful wall chaser for the hardest materials

APPLICATION:

- Milling of slots and ducts in concrete, sand-lime brick, brickwork
- Electrical installations, sanitary, heating and ventilation construction

FEATURES:

- Nearly dust-free immersion and slitting due to hinged hood
- Split work spindle - possibility of mounting joint milling discs up to 10mm segment thickness
- Powerful 2300 W motor
- Electronic - soft start, temperature control and over current cut-off, overload indication
- Parallel handle position - comfortable working position
- Locking for suction hose - avoids unintentional loosening of the hose during milling
- Adjustable milling depth - without the need for a tool
- Spindle lock - easy tool change
- Slim design, small distance between dust hood and diamond blades for working up to 15 mm from the edge
- Slot widths of 7-60 mm
- Nozzle diameter 35 mm - direct connection of industrial vacuum cleaner of EIBENSTOCK DSS series



saves at least
50% time

Save the second slot operation for thicker pipes with insulation / sewage pipes Ø 40, 50 mm!



Floor guide device EMF 180 (see accessories page 116)















Fatigue-free creation of slits and expansion joints in floors



Even faster with EIBENSTOCK „Easy Break Out“ (see accessories page 116)



















Distance discs for the using of 3 blades - fast breaking by a center slot

A Sawing/Cutting/Slitting ACCESSORIES

FOR DIAMOND SAWS			
	1	Guide rail (with 2 screw clamps) 750 mm 1500 mm	37461000 37462000
	2	Assembly rail for guide rail (with 4 grub screws)	37463000
	3	Suction holder for guide rail 2 parts	37464000
	4	Diamond cutting disc for concrete and hard natural stone Ø 180 mm	37443000
	5	Diamond cutting disc for concrete and hard natural stone Ø 200 mm	37444000
	6	Diamond cutting disc for tiles and stoneware Ø 125 mm	3744B000
	7	Diamond milling disc Ø 125 mm, milling width 7 mm	3744C000
	8	Diamond disc for curved cut Ø 115 mm	3744A000
	9	Plate enlargement for ETT 700/ETT 1200 167 x 485 mm	09803000
	10	Water tank 5 l plastic	35811000
	11	Water tank 10 l metal	35812000
FOR STONE CUTTING SAW			
	12	Diamond universal cutting disc Ø 350 mm	37475000
	13	Plug (aluminium) for dust extraction Absolutely necessary when cutting metal!	37476000
	14	Diamond cutting disc Ø 350 mm	37471000
	15	Folding table with board B 400 x L 600 x H 850 mm	37473000



A Sawing/Cutting/Slitting ACCESSORIES

FOR CUTTING AND GRINDING SYSTEMS			
	16	Diamond cutting disc Ø 230 mm	37448000
	17	Diamond cutting disc universal Ø 350 mm for ETR 350/ETR 350 P/ETR 350.1 P ETR 400 P/ETR 400.1 P	37475000
	18	Plug (aluminium) for dust extraction Absolutely necessary when cutting metal!	37476000
	19	Diamond cutting disc Premium, Ø 350 mm for ETR 350/ETR 350 P/ETR 350.1 P	3744G000
		Diamond cutting disc Premium, Ø 400 mm for ETR 400 P/ETR 400.1 P	3744T000
	20	Diamond cutting disc near to the edge Premium, Ø 350 mm, ETR 350/ETR 350 P/ETR 350.1 P	3744H000
		Diamond cutting disc near to the edge Premium, Ø 400 mm, ETR 400 P/ETR 400.1 P	3744V000
	21	Set of Adapter for cutting near to the edge for ETR 350/ETR 350 P/ETR 350.1 P	3744K000
		Set of Adapter for cutting near to the edge for ETR 400 P/ETR 400.1 P	3744W000
	22	Adjustment and limitation for cutting depth incl. cover plate - ETR 350 P/ETR 350.1 P	3744L000
		Adjustment and limitation for cutting depth incl. cover plate - ETR 400 P/ETR 400.1 P	3744U000
	23	Set of Guide rails 200 cm for ETR 350/ETR 350 P/ETR 350.1 P/ETR 400 P/ETR 400.1 P 2x Guide rail 100 cm incl. machine holder, connection and mounting	3744N000
Please order the fixing set as well!			
	24	Guide rail 100 cm for ETR 350/ETR 350 P/ETR 350.1 P/ETR 400 P/ETR 400.1 P incl. connection and mounting	3744P000
Please order the fixing set as well!			
	25	Fastening set for Guide rails for ETR 350/ETR 350 P/ETR 350.1 P/ETR 400 P/ETR 400.1 P	35729000
Required for assembly!			
	26	Blade set Universal Premium, 2 parts	37452000
	27	Diamond blade Premium Ø 125 mm	3744D000
	28	Diamond blade Standard Ø 150 mm	37440000
	29	Diamond blade Premium Ø 150 mm	37441000
	30	Diamond blade Premium Ø 180 mm	37443000
	31	Distance discs for the using of 3 blades for EMF 150.1/EMF 180	3744E000
	32	Distance discs for the using of 4 blades for EMF 150.1/EMF 180	37445000
	33	Distance discs for the using of 3 blades for EMF 180.1/EMF 180.2	3744S000
	34	V-joint plate Ø 180 mm for EMF 180 - for creating expansion joints	37442000
	35	Floor guiding drive EMF 180.1/EMF 180.2	3744X000

POLISHING CALENDERING



Model	Page	Max. disc diameter	Spindle connection	Power input	Rated speed
 <p>WPN 180 05710000</p>	120	180 mm	M 14 male	1200 W	1500-2800 rpm
 <p>ESM 1310 0541F000</p>	121	120 mm	Ø 19 mm	1300 W	1300-3050 rpm
 <p>ESM 1311 Set 0541K000</p>	121	120 mm	Ø 19 mm	1300 W	1300-3050 rpm



Slim housing design

compact,
well balanced design

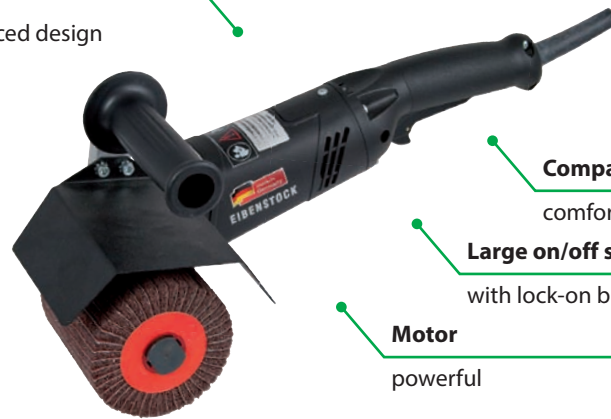

Compact handle

comfortable use

Large on/off switch

with lock-on button

Motor

powerful

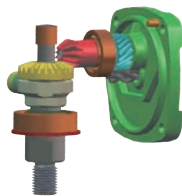

• Double transmission reduction (ESM 1310)

- higher torque at the shaft
- high performance at lower speeds
- minimum motor load, durable

FEATURES OF POLISHER/CALENDER

The EIBENSTOCK range of polishers and calender machines are especially good for the smoothing and polishing in the wood and motor industries.

The machines are easy to use, powerful and long lasting.



Wet-angle polisher WPN 180

Wet angled polisher with the proved 60° gearbox

APPLICATION:

- Wet polishing and sanding of different surfaces, edges and curves
- Removal of scratches
- Different kinds of stone

FEATURES:

- Electronic – soft start, stepless speed control, temperature control and over current cut-off
- 60° gearbox – better view on the surface you want to work on, easy to get to hard to reach areas and tight angles
- Dust protected gearing bearings by labyrinth-guide – low wearing
- External water supply below the motor

Ø 180



SPECIFICATIONS	WPN 180
Power input	1200 W
Rated voltage	230 V ~
No-load speed	1500-2800 rpm
Max. disc diameter	180 mm
Spindle connection	M 14 male
Weight	4.4 kg
Order no.	05710000
Supplied	in a box incl. support handle, without accessories



Calender ESM 1310 / ESM 1311 Set

The handy, high torque machine

APPLICATION:

- Sanding, deburring, smoothing, brushing, structuring, matting, calendaring and polishing
- From rough sanding to fine sanding to high gloss
- Wood, metal, plastic

FEATURES:

- Electronic – soft start, stepless speed regulation and constant speed, temperature control and over current cut-off
- Motor can take high loads – durable, maximum power for the whole speed range
- Double transmission reduction – maximum torque, low motor load, durable
- Dust protected gearing bearings by labyrinth-guide – low wearing



ESM 1310



ESM 1311 Set







SPECIFICATIONS	ESM 1310	ESM 1311 Set
Power input	1300 W	1300 W
Rated voltage	230 V ~	230 V ~
No-load speed	1300-3050 rpm	1300-3050 rpm
Max. tool diameter	120 mm	120 mm
Max. connection shaft	100 mm	100 mm
Spindle connection	Ø 19 mm	Ø 19 mm
Weight	2.8 kg	3.7 kg
Order no.	0541F000	0541K000
Supplied	in a box without accessories	in a case with exhaust hood and roller brush for wood texturing







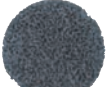







Polishing/Calendering ACCESSORIES

FOR POLISHER

1		1	Sanding disc plastic, M 14	
			Ø 100 mm	37300000
			Ø 125 mm	37302000
			Ø 150 mm	37303000
			Ø 178 mm	37304000
2		2	Polishing sponges for sanding disc	
			Ø 180 mm - fine, honey combed	37328000
			Ø 180 mm - rough, smooth	37329000
3		3	Wool polishing bonnet for sanding disc (without intermediate layer)	
			Ø 125 mm	37325000
			Ø 178 mm	37327000
4		4	Fleece disc for sanding disc (synthetic resin-bonded fleece on backing pad)	
			Ø 115 mm	37311000
			Ø 125 mm	37313000
			Ø 180 mm	37315000
5		5	Case for machine and accessories (ELP 1300, EPO 1310, EPO 1401, EPN 1310, EPN 1310 P)	37330000



FOR CALENDER

6		6	Starter kit finishing wheels 1x sanding flap wheel (rough), 1x polishing fleece wheel (rough), 1x polishing fleece wheel (fine), 1x flap-fleece combi wheel (medium)	37520000
7		7	Sanding flap wheel, 4 pieces - fine grinding, removal and cleaning of welds	
			Ø 100 x B 100 mm - rough (P60)	37521000
			Ø 100 x B 100 mm - medium (P80)	37522000
			Ø 100 x B 100 mm - fine (P120)	37523000
8		8	Polishing fleece wheel, 4 pieces - removal of oxide films, refinish	
			Ø 100 x B 100 mm - rough	37525000
			Ø 100 x B 100 mm - medium	37526000
			Ø 100 x B 100 mm - fine	37527000
9		9	Flap-fleece combi wheel, 4 pieces - deburring and cleaning, refinish	
			Ø 100 x B 100 mm - rough (P60)	37531000
			Ø 100 x B 100 mm - medium (P100)	37532000
			Ø 100 x B 100 mm - fine (P150)	37533000
10		10	Nylon fleece wheel - removal of oxide films, lacquers	37535000
			Ø 100 x B 100 mm	
11		11	Rubber air roller for sanding sleeves	37512000
			Ø 100 x B 100 mm	
12		12	Sanding sleeve, 10 pieces - removal of oxide films, deburring and cleaning	
			Ø 100 x B 100 mm - rough (P60)	37513000
13			Ø 100 x B 100 mm - medium (P80)	37514000
			Ø 100 x B 100 mm - fine (P150)	37515000
14		13	Roller brush - for wood texturing	37537000
			Ø 100 x B 100 mm - Nylon (K80)	
		14	Exhaust hood	37501000
15		15	Case for machine and accessories	37330000

PUMP~ & VACUUMING





Model		Page	Tank volume	Dust volume	Max. power input
SS 1401 L 09921000		124	25 l	21 l	1250 W
DSS 25 A 09915000		125	25 l	20 l	1400 W
DSS 50 A 09916000		125	50 l	45 l	1400 W
DSS 25 M 09917000		126	25 l	20 l	1400 W
DSS 35 M iP 09919000		127	35 l	25 l	1600 W
Pump vacuum cleaner EPS 50 09927000 NEW		128	50 l	–	1300 W



Dust retention capacity min. 99 % according to BGIA dust class L

25 l

PUSH & CLEAN:

Hold the hose or inlet fitting (1) and press the filter cleaning button (2)

Cleaning of the filter by strong air stream (3)

Continue working at full capacity

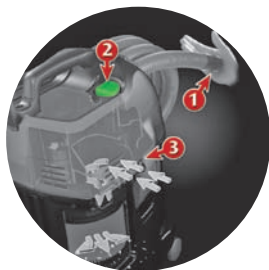

SPECIFICATIONS	SS 1401 L
Max. power input	1250 W
Rated voltage	230 V ~
Tank volume (max.)	25 l
Dust volume (net)	21 l
Max. air flow	60 l/s
Max. vacuum	210 mbar
Dimensions L x B x H	505 x 385 x 375 mm
Weight	7.7 kg
Order no.	09921000

Supplied: in a box incl. 3.5 m suction hose (Ø 32 mm), 2 suction tubes (aluminium), handle tube with air switch, floor nozzle, crevices nozzle, universal nozzle, round brush, tool adapter with suction power regulation, fleece filter bag, disposal bag

Construction cleaner SS 1401 L

The compact and lightweight construction cleaner of dust class L

APPLICATION:

- Vacuuming of sludges (wet)
- Cleaning of cars, living and business rooms

FEATURES:

- Push&Clean filter cleaning system
- Large filter surface 3000 cm² – good filter effect
- High efficiency by 210 mbar vacuum
- Float valve – level monitoring when vacuuming liquids
- PET folded filter
- Blower function – blowing inaccessible areas
- Comfortable handle
- Cable and hose hook
- Accessory depot for suction nozzles and suction tubes
- Safety Cleaner dust class L, suitable for dust with WEL-values > 1 mg/m³
- with automatic switch-on for attached machines



Industrial vacuum cleaner DSS 25 A and DSS 50 A

The compact wet and dry cleaners

APPLICATION:

- Vacuuming of sludges (wet)
- Cleaning of cars, living and business rooms

FEATURES:

- Automatic filter cleaning (electromagnetic pulse)
 - cleaning of the filter, working without, complete dedusting of the cartridges
- Electronic – soft start with deferred rundown switching
- Flow rate indicator – optical monitoring of the suction performance
- Consistently high flow rate – increases filter life, reduction of time and costs
- Water recognition with sensor disconnection
- 2 polyester filter cassettes – high efficiency, durable, easy to clean
- Filter surface 8600 cm² – high constant suction performance
- Compact design – smaller height, same volume
- Special-plastic tank – low centre of gravity, easy cleaning of walls
- Large storage tray for accessories and machines
- Hose connection with bayonet and twist balancing
- Hose ends are interchangeable – easy hose extension, dust free transport

25 l

50 l

SPECIFICATIONS	DSS 25 A	DSS 50 A
Max. power input	1400 W	1400 W
Rated voltage	230 V ~	230 V ~
Tank volume (max.)	25 l	50 l
Dust volume (net)	20 l	45 l
Max. air flow	73 l/s	73 l/s
Max. vacuum	270 mbar	270 mbar
Dimensions L x B x H (mm)	457 x 400 x 535	580 x 470 x 640
Weight	11.7 kg	16.7 kg
Order no.	09915000	09916000

Supplied: in a box incl. 5 m suction hose (Ø 35 mm), universal-adapter, nozzle for floor and crevices, handle tube with air switch, 2 suction tubes (plastic), velcro strip, holder for accessories



25 l

**Dust retention capacity
min. 99.9 % according to
BGIA dust class M**

SPECIFICATIONS
DSS 25 M

Max. power input	1400 W
Rated voltage	230 V ~
Tank volume (max.)	25 l
Dust volume (net)	20 l
Max. air flow	73 l/s
Max. vacuum	270 mbar
Dimensions L x B x H	457 x 400 x 535 mm
Weight	11.7 kg

Order no. 09917000

Supplied: in a box incl. 5 m suction hose (Ø 35 mm), universal adapter, coarse dirt floor nozzle, crevices nozzle, handle tube with air switch, 2 suction tubes (plastic), holder for accessories, disposal bag



Industrial vacuum cleaner DSS 25 M

The „M“-cleaner for harmful dust

APPLICATION:

- Vacuuming of dust (dry) and sludges (wet)

FEATURES:

- Automatic filter cleaning (electromagnetic pulse)
 - cleaning of the filter, complete dedusting of the cartridges
- Electronic – soft start with deferred rundown switching
- Flow rate indicator – optical and acoustic monitoring of the suction performance
- Volume flow control adjustable to different hose diameters
- Consistently high flow rate – increases filter life, reduction of time and costs
- Diffuser – avoids stirring up of exhaust air
- Water recognition with sensor disconnection
- 2 polyester filter cassettes – high efficiency, durable, easy to clean
- Filter surface 8600 cm² – high constant suction performance
- Compact design – smaller height, same volume
- Special-plastic tank – low centre of gravity, easy cleaning of walls
- Special plastic bag for clean disposal
- Large storage tray for accessories and machines
- Hose connection with bayonet and twist balancing
- Hose ends are interchangeable – easy hose extension, dust free transport
- Flush, stable fasteners

Industrial vacuum cleaner DSS 35 M iP

The „M“-cleaner for harmful dust with permanent pulse filter cleaning

APPLICATION:

- Vacuuming of dust (dry) and sludges (wet)

FEATURES:

- Automatic electromagnetic pulse filter cleaning with "Permanent Clean" – cleans the filters permanently during the vacuuming process – without interruption of the intake flow!
- Pressure difference controlled
- 300 g force filter cleaning – also perfect working with plaster
- Constantly high air flow also during filter cleaning
- Electronic – soft start with deferred rundown switching
- Flow rate indicator – optical and acoustic monitoring of the suction performance
- Volume flow control adjustable to different hose diameters
- Diffuser – avoids stirring up of exhaust air
- Water recognition with sensor disconnection
- 2 polyester filter cassettes – high efficiency, durable
- Filter surface 8600 cm² – high constant suction performance
- Special-plastic tank – low centre of gravity, easy cleaning of walls
- Special plastic bag for clean disposal
- Large storage tray for accessories and machines
- Carrying handle with retractable cable hook and hose take-up
- Hose connection with bayonet and twist balancing
- Hose ends are interchangeable – easy hose extension, dust free transport
- Flush, stabel fasteners



Comparison: slitting of channels of the same length

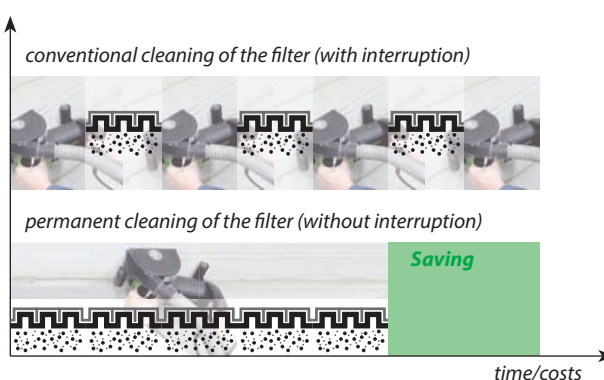

**Dust retention capacity
min. 99.9 % according to
BGIA dust class M**

35 l

SPECIFICATIONS	DSS 35 M iP
Max. power input	1600 W
Rated voltage	230 V ~
Tank volume (max.)	35 l
Dust volume (net)	25 l
Max. air flow	75 l/s
Max. vacuum	280 mbar
Dimensions L x B x H	550 x 400 x 550 mm
Weight	14.0 kg
Order no.	09919000

Supplied: in a box incl. 5 m suction hose (Ø 35 mm), universal-adapter, coarse dirt floor nozzle, crevices nozzle, handle tube with air switch, 2 suction tubes (plastic), holder for accessories, disposal bag





50 l



NEW

Pump vacuum cleaner EPS 50

The powerful wet vacuum cleaner with pump function

APPLICATION:

- Absorb water up to 2.3 m deep, simultaneous pumping and delivery up to 9 m high
- faster and more efficient compared to conventional methods
- on construction sites, in case of floods, for fire restoration, pipe damage, flat roof restoration, pond or pool cleaning and other cleaning tasks
- for roofers, construction companies, fire brigades, technical relief organizations, caretaker services, housing associations

FEATURES:

- particularly robust container made of impact-resistant plastic
- high-performance pump with a flow volume of up to 14,000 Litres per hour
- separate filter net for rough particle
- suction length max. 8 m, suction height max. 2,3 m
- 10 m wastewater hose with C-pipe connection
- also suitable for normal vacuum use
- high safety through PRCD circuit breaker



powerful pump



C-pipe connection for wastewater

SPECIFICATIONS

EPS 50

Power input (cleaner)	1300 W
Power input (pump)	900 W
Rated voltage	230 V ~
Max. suction	230 mbar
Volume flow rate (Vac. cleaner)	70 l/s
Volume flow rate (pump)	14 000 l/h
Max. pumping head	9 m
Tank volume 50 l	50 l (gross)
Wastewater connection	C-pipe
Length of suction hose	7 m
Length of discharge hose 10 m	10 m
Weight	15 kg

Order no. 09927000

Supplied: 4 x 0,5 m suction hose plastic \varnothing 38 mm, 7 m suction hose, 10 m discharge hose, integrated wastewater pump, filter net with zipper, pond nozzle, crevice nozzle, wet floor nozzle 360 mm width



		SS 1401 L	DSS 25	DSS 50	DSS 35		
	1	Accessory-kit stainless steel 2 stainless steel suction tubes, handle tube with air switch, floor nozzle, padding nozzle, crevices nozzle, nozzle body with water insert	-	x	x	x	35315000
	2	Fleece filter bag (5 pieces)	x	-	-	-	35323000
			-	x	-	x	35321000
			-	-	x	-	35326000
	3	Disposal bag (5 pieces) for M-cleaners	-	x	x	x	35320000
			x	-	-	-	35324000
	4	Filter cassettes polyester, 2 parts	-	x	x	x	35301000
	5	Folded filter	x	-	-	-	35322000
	6	Suction tubes (plastic), 2 parts	x	x	x	x	35314000
	7	Handle tube with air switch	-	x	x	x	35207000
	8	Nozzle body with water insert	-	x	x	x	35308000
	9	Water nozzle	x	x	x	x	35311000
	10	Rubber nozzle, cone-shaped	x	x	x	x	35205000
	11	Floor nozzle (switchable)	x	x	x	x	35304000
	12	Coarse dirt floor nozzle	x	x	x	x	35327000
	13	Crevices nozzle	x	x	x	x	35203000
	14	Rubber sleeve, stepped Ø 25,5-26,5 mm/Ø 30,5-32,5 mm/Ø 36-38 mm	x	x	x	x	35316000
	15	Hose connection, vacuum cleaner sided (bayonet)	-	x	x	x	35313000
	16	Hose connection, machine sided	-	x	x	x	35313500
	17	Suction hose Ø 35 mm					
		5.00 m	-	x	x	x	35302000
		3.20 m	-	x	x	x	35307000
	18	Antistatic hose Ø 35 mm					
		5.00 m	-	x	x	x	35319000

Elektrowerkzeuge GmbH Eibenstock
Auersbergstraße 10 · D-08309 Eibenstock, Germany

Phone: + 49 37752 503-0
Fax: + 49 37752 2019



GC 21 - 3. Edition

Technical changes, errors and omissions excepted.
Illustrations may vary.